



MILITARY IMPLEMENTATION PLAN

2023-2025 ARMY PEOPLE STRATEGY





THE ARMY PEOPLE STRATEGY
Military Implementation Plan

1 October 2022

Army People Strategy: Military Implementation Plan 2.0

The Soldiers in today's Army represent the best of America. Today's youth have significant career opportunities. The Army must find new ways to connect with the Nation and inspire America's youth to serve.

We are pleased to present the Department of the Army Military Implementation Plan (MIP 2.0) for Fiscal Years 2023-2025. The MIP 2.0 focuses our efforts to manage the unique talents of our most valued resource—people.

The MIP 2.0 outlines how to best position the Army to acquire diverse talent, invest in training and education, and enhance Total Force readiness while retaining valuable experience. The Army People Strategy's lines of efforts undergird our mission. Therefore, we will incorporate tasks, milestones, and measurements to build cohesive teams to ensure they are ready, professional, diverse, and integrated.

This detailed and comprehensive plan will lead us to a Multi-Domain Capable Army of 2030. We will innovate to acquire, train, educate, and credential our workforce while focusing on a 21st-century Talent Management System, becoming a data-centric enterprise.

This plan addresses challenges we must overcome over the next three years, including institutionalizing talent management, sustaining crucial Quality of Life efforts, and meeting resource requirements.

This MIP 2.0 provides the Army with an adaptable plan to meet the needs of the Force and respond to challenging conditions while supporting our Soldiers and Families.

We remain committed to the All-Volunteer Force as we transform the way we acquire, develop, employ, and retain our nation's Soldiers. We will modernize our approach to talent management and development, build readiness, and take care of our people.



Douglas F. Stitt
Lieutenant General
Deputy Chief of Staff,
G-1



Gary M. Brito
General, U.S. Army
Commanding General
Training and Doctrine
Command



Yvette K. Bourcicot
Acting Assistant Secretary of the Army
(Manpower & Reserve Affairs)

Army People Strategy: Military Implementation Plan 2.0

Table of Contents

Introduction.....	1
Chapter 1: Address the Secretary of the Army’s Objectives	11
Chapter 2: Care for Soldiers, DA Civilians, and Families	15
Chapter 3: Acquire Talent.....	37
Chapter 4: Develop Talent.....	61
Chapter 5: Employ Talent.....	86
Chapter 6: Retain Talent.....	103
Chapter 7: Advance Diversity, Equity, Inclusion, and Accessibility	116
Chapter 8: Build Resiliency.....	126
Chapter 9: Sexual Harassment/Assault Response and Prevention	159
Chapter 10: Holistic Health & Fitness	166
Chapter 11: People Analytics	171
Chapter 12: Institutionalize Talent Management.....	185
Chapter 13: Modernize and Sustain the Army Workforce	189
Chapter 14: Assessment	197
Acronym List.....	203



Introduction

Military Implementation Plan 2.0

Army People Strategy: Military Implementation Plan 2.0

Introduction

In 2020, the Army published two plans – the Military Implementation Plan (MIP) and Civilian Implementation Plan (CIP) – which operationalized the *Army People Strategy* (APS) and better positioned the Army to compete for and acquire diverse talent, fully develop its Soldiers and DA Civilians, employ the full range of their capabilities, and retain their experience for the future. The 2023-2025 Military Implementation Plan 2.0 (MIP 2.0) operationalizes the *Army People Strategy* for military personnel.

The MIP 2.0 builds on the inaugural MIP's successes in Army readiness to identify gaps, implement solutions, and measure improvements so that the Army can assess its progress for future success. The APS and the MIP describe the Army military talent management vision, enabling infrastructure, and concerted unity of effort needed to acquire, develop, employ, and retain military talent in support of Army readiness. Specifically, the strategy and plan:

- Manage and develop resilient Army Soldiers in accomplishing the Army mission;
- Ensure mission requirements drive investment in Army Soldier talent;
- Set conditions to align force capabilities with changing mission requirements;
- Reduce threats to the force by preventing/reducing harmful behaviors; and
- Overcome barriers to enlisting in the Army to enhance Army readiness.

Vision / Mission – Published in October 2019, the APS vision and mission are clear – The Total Army will acquire, develop, employ, and retain Soldiers and DA Civilians of diverse talents needed to achieve Total Army readiness. Our vision is to build cohesive teams for the Joint Force by maximizing the talents of our people, the Army's greatest strength and most important weapon system.

Strategic Approach – Our strategic approach supports the Secretary's objectives to become a more data-driven Army, build positive command climate at scale, reduce harmful behaviors, and adapt the way we recruit and retain talent. To do this we will pursue the four lines of effort (Acquire, Develop, Employ, and Retain Talent) outlined in the APS, supported by four critical enablers (twenty-first century talent management, Quality of Life, Army Culture, and Resource/Authorities) to achieve a strategic outcome of cohesive teams that are ready, professional, diverse, and integrated.

We include material from the Diversity, Equity, and Inclusion, Sexual Assault (SA) and Harassment Prevention, Force Resiliency, Health and Wellness, and People Analytics Annexes. We leverage the Arctic Dominance, Modernization, Digital Transformation, Race for Talent, and Army Integrated Prevention Strategies. We have placed additional emphasis upon issues of Quality of Life (QOL), institutionalizing talent management, and modernizing the workforce, based upon learnings from the original MIP execution.

Army People Strategy: Military Implementation Plan 2.0

Acknowledging this scope, our activities encompass four Efforts.

Effort 1: Compete for and Manage Talent - This effort encompasses the *Army People Strategy's* four Lines of Effort

Effort 2: Care for Soldiers, DA Civilians, and Families - This effort encompasses issues of QOL, leader development, and SECARMY's Building Positive Command Climates and Reducing Harmful Behaviors objectives.

Effort 3: Institutionalize Talent Management - This effort acknowledges the broad impact of Talent Management, incorporates the Army Talent Management Task Force's initiatives, and transitions Talent Management into a permanent Army structure.

Effort 4: Modernize and Sustain the Army Workforce - This effort addresses specific strategic drivers in the people space, including the Secretary of the Army's (SECARMY) Adapt Recruiting and Retention objective, recruiting and training Arctic and Cyber warriors, balancing the force structure for the future, and identifying specific science and technology needs.

See Figure 1 for a graphical depiction of these efforts.

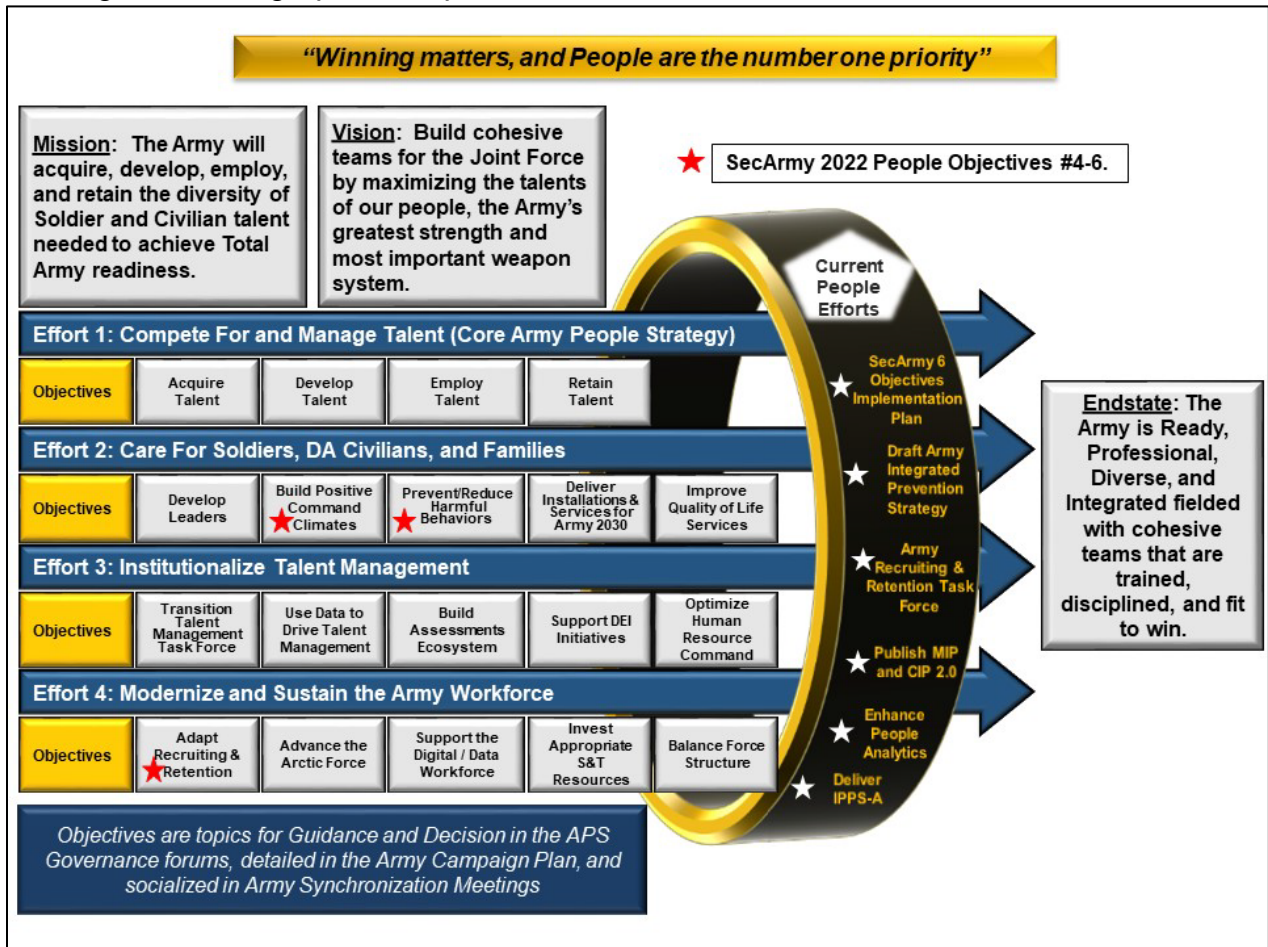

Figure 1: Strategic Approach through 2030

Army People Strategy: Military Implementation Plan 2.0

The APS Lines of Effort

The following core APS Lines of Effort (LOEs) organize movement towards four Strategic Outcomes. Each disaggregates into three or more supporting objective areas, providing a framework for the alignment of specific tasks and initiatives described in this Implementation Plan. The APS identifies Lead Integrators for the LOEs. These individuals are responsible for coordinating inclusion of key tasks and initiatives within each LOE.

Acquire Talent (APS LOE 1) – Lead Integrator: U.S. Army Training & Doctrine Command (TRADOC) in coordination with the United States Military Academy (USMA) and the Army Enterprise Marketing Office (AEMO). Creating a robust pipeline of new talent into the Total Army is the main effort through 2030 because it will ensure that we have the breadth and depth of talent needed for the MDO-capable force of 2035 envisioned by the Army Strategy. This LOE identifies the key tasks needed for the Army to acquire the right people using better screening and assessments, improving marketing techniques and content, and streamlining recruiting and onboarding. Improving Initial Entry Training (IET) graduation rates, increasing productivity, and gaining efficiencies enable the Army to save and reinvest valuable resources. To access the right talent, we must align talented Army professionals to the generating force and incentivize them accordingly. By using an integrated talent management approach to select accessions enterprise personnel, we will strengthen Army culture by integrating recruits. We will accomplish this line of effort through tasks aligned to the market, recruit, and onboard supporting objectives.

Develop Talent (APS LOE 2) – Lead Integrator: TRADOC in coordination with Headquarters Department of the Army (HQDA), Deputy Chief of Staff (DCS) G-1, and Army Futures Command (AFC). This LOE identifies the necessary tasks to extend each Army professional's talents, close talent gaps, and maximize contributions to the Total Army. These tasks will ensure the Army has systems in place to understand and value the talents of its professionals. We will accomplish this line of effort by educating, training, and credentialing Army professionals.

Employ Talent (APS LOE 3) – Lead Integrator: DCS G-1 in coordination with the Army Talent Management Task Force (ATMTF) and TRADOC. This LOE identifies the key tasks needed to maximize engaging Army professionals by aligning their unique talents against organizational talent demands. We will accomplish this line of effort through tasks focused on identifying, aligning, and advancing Army professionals.

Retain Talent (APS LOE 4) – Lead Integrator: DCS G-1 in coordination with ATMTF. This LOE identifies the key tasks needed to identify Army professionals with in-demand talents and engage them. Engagement includes both compensatory and non-compensatory solutions and opportunities, including migration across the Army. We will accomplish this line of effort through tasks centered on engaging, compensating, and transitioning Army professionals.

LOE Implementation Priority - We will proceed along all four LOEs simultaneously. LOE 1 (Acquire Talent) remains the primary implementation priority through 2030. This priority will

Army People Strategy: Military Implementation Plan 2.0

be accomplished with added emphasis on modernizing the entire accessions enterprise by marketing, recruiting, and onboarding the Total Army.

The APS Annexes

Several annexes expand upon the core *Army People Strategy* LOEs, to address Resiliency; Sexual Harassment (SH)/Sexual Assault Response and Prevention; Holistic Health and Fitness; Diversity, Equity, Inclusion, and Accessibility; and People Analytics. MIP 2.0 incorporates each of these annexes into its own chapter, instead of separate annexes. These efforts are integral to how the Army will continue to integrate the Secretary of the Army's (SECARMY) objectives, produce new initiatives to improve command climates, prevent harmful behaviors, and respect and support Soldiers.

Additional Efforts

Based upon the SECARMY's objectives and lessons learned throughout the execution of previous MIP Tasks, we have identified additional efforts and objectives to add to this updated document. The majority can be found in Efforts 2-3 of Figure 1. Many of these efforts are topics previously addressed as critical enablers or issues that arose during execution in prior fiscal years. Expanding the scope of this document to directly address these allows for better planning, coordination, and tracking of these efforts.

Strategic Outcomes

By 2030, the desired end-state for each outcome is:

Ready – The Army uses a range of technologies, incentives, programs, and policies to identify the talents of its people and the talent demands of its organizations. It applies data-driven analytical tools to acquire, develop, employ, and retain people. These tools drive a dynamic and accurate long-term workforce planning system that reduces talent gaps and increases Army readiness.

Professional – The Army is a profession, a highly expert, certified, and credentialed force resulting from years of increasingly rigorous training, education, and leader development. Soldiers treat one another with dignity and respect, retaining the trust and confidence of the American people and each other, and are dedicated to a lifetime of service to the nation, in and out of uniform.

Diverse – The Army is committed to equality of opportunity, providing Soldiers with fulfilling and rewarding professional careers. As an inclusive and representative American institution, we ensure that people possess a diversity of *talent* – knowledge, skills, behaviors, and preferences.

Integrated – The Army has overcome legal, cultural, and technological barriers to fully harmonize the efforts and capabilities of its Total Force: Active, Guard, Reserve Soldiers, and DA Civilians. This transformation has dramatically increased the ability to move between the Active, Guard, and Reserve, and among military and civilian workforces.

Army People Strategy: Military Implementation Plan 2.0

Near-Term Priorities - The *Army People Strategy* lists six near term priorities of particular importance to Army Senior Leaders over the next two years. This Implementation Plan prioritizes five military efforts to accomplish these priorities in a planned and coordinated approach.

- Reform Quality of Life programs for both Soldiers and DA Civilians based on the Army senior leaders prioritizing 1) Housing and barracks, 2) Healthcare, 3) Childcare, 4) Spouse Employment, 5) Permanent Change of Station moves, and 6) Support and Resilience.
- The Army Enterprise Marketing Office will transform all marketing communications, technologies, and operations, ensuring we attract the military and civilian talent needed to remain the world's premier combat force.
- Reform accession activities based on an end-to-end evaluation of Total Army accession and retention programs. Develop and implement programs, policies, and systems to attract and align new Soldiers and DA Civilians with best-fit jobs across the Army and improve Initial Military Training graduation rates. Lastly, conduct Army Accessions Information Environment design, prototyping, and phased releases.
- Resource Integrated Personnel and Pay System – Army (IPPS-A) on schedule and bring the Assignment Interactive Module 2.0 (AIM 2.0) to full operating capability for military personnel.
- Research, design, and pilot a suite of talent assessments for Soldiers and DA Civilians for future scaling.

Governance

MIP 2.0 describes the governance structure for the Efforts. The governance body will prioritize and execute all Army people management efforts. The Army will continue to execute the *Army People Strategy* through a synchronized effort with cross-Army working groups, robust communication and change management strategies. Governance processes will also facilitate senior leader support up to the Chief of Staff of the Army (CSA) and the Secretary of the Army (SECARMY). The governance chair is the Assistant Secretary of the Army (Manpower and Reserve Affairs) (ASA(M&RA)) in coordination with TRADOC to provide oversight and direction to the Total Army People Enterprise.

Army People Strategy: Military Implementation Plan 2.0

Across all the MIP 2.0 efforts, we will seek agile ways to innovate current governance processes to increase decision-making space and time. To streamline and increase the efficiency of the people governance outcomes, we will continue to use three primary forums: the Army People Strategy Board of Directors (APS-BoD), an Executive Steering Committee (ESC), and a Senior Leader Steering Committee (SLSC) that are assigned specific outcomes (**Error! Reference source not found.**). We will use these forums to synchronize efforts, de-conflict issues, build consensus, and develop solutions for higher level decision-making.

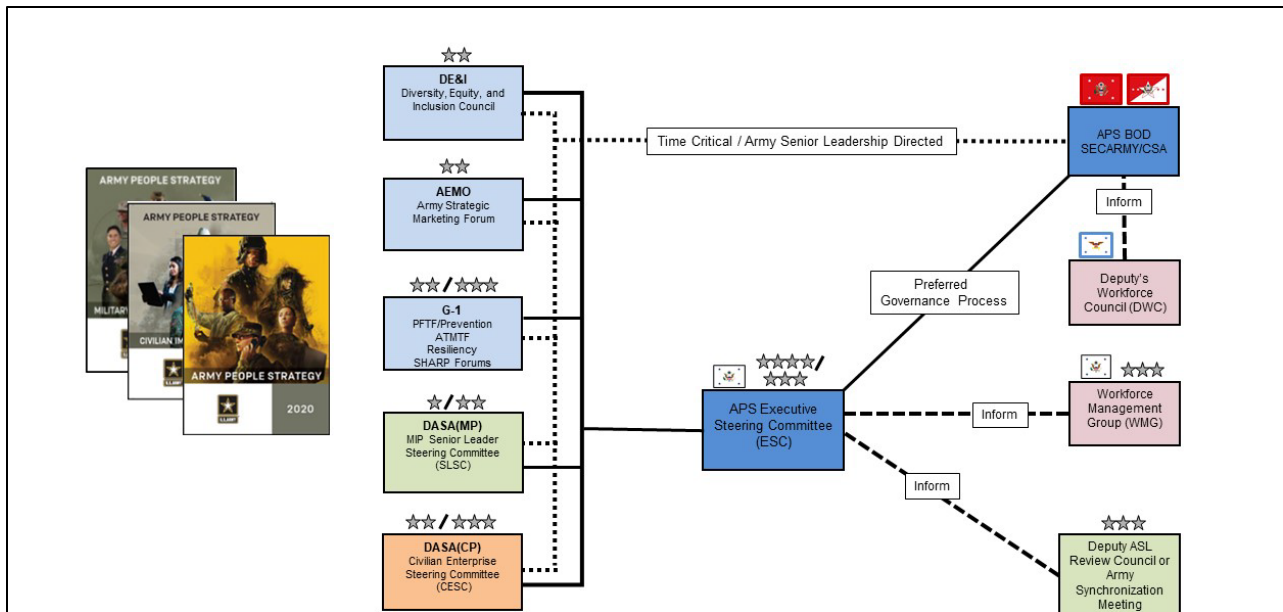

Figure 2: MIP Governance Structure

The MIP SLSC, chaired by the Deputy Assistant Secretary of the Army - Military Personnel (DASA-MP) in coordination with the TRADOC G-3/5/7, will report on the overall progress of the MIP to the ESC, and gain approval/guidance on objective completion and results. The MIP SLSC leads will ensure the objectives of the Army People Strategy are understood at all levels, and will advise the ESC on the Planning, Programming, Budgeting, and Execution (PPBE) process as it relates to funding of MIP pilots and programs.

MIP 1.0 previously incorporated several Annexes to address particular concerns, such as threats to the force, modernizing talent management, and data analytics. Due to the timelines and Army command and control structures involved, content from each Annex was originally controlled through their own analogues to the MIP SLSC. To enhance visibility and unity of effort, these former Annexes are now folded into the MIP as chapters akin to the various LOEs. Each DASA/program director will report their respective year-to-date achievements, measures, and progress to the MIP SLSC regularly.

Army People Strategy: Military Implementation Plan 2.0

The ESC will receive progress reports and proposed solutions on Army people management efforts and decide which issues go to the APS-BoD for Army Senior Leader(s) approval and/or further guidance on policy and funding decisions. The committee will also receive Marketing, Accessions, Retention, and Strength Updates. In addition, it will also report the overall progress of MIP 2.0 and CIP 2022 to the APS-BoD for information, gain approval to proceed, and/or receive guidance. The responsible Senior Executive Service members with oversight of each Functional Area (FA) will brief their updates to the ESC.

The *Army People Strategy* Board of Directors (APS-BoD) is chaired by the SECARMY and CSA. The focus is on strategic people issues, obtaining guidance, and issuing decisions associated with the *Army People Strategy* and the entire people enterprise.

MIP 2.0 adds the development of several tasks to support governance and data collection efforts to include expansion to cover efforts in previous Annexes. These newly developed efforts are published in strategies with People implications and aligned to the SECARMY's objectives. The total number of existing tasks changed to accommodate the expansion of efforts and reorganization of MIP.

Task 0.0.a: Update Point of Contact (POC) lists

Office of Primary Responsibility (OPR): DASA-MP; **OCR:** ASA(M&RA); **Data Owner(s):** All MIP Tasked Organizations

Create and maintain up-to-date by-name POC lists for all LOEs, Tasks, and Milestones. Organizations with explicit equities in the MIP (OPRs, OCRs, Owners, etc.) shall provide quarterly updates to their by-name POC lists to ASA(M&RA) and DASA-MP.

Task End State: The APS MIP Team and stakeholders have clear and current information about changes to the MIP 2.0 Executive Order (EXORD) and who to contact for any question or action.

Dependencies: Tasked organizations request reassignment of tasks thought incorrectly assigned.

Milestones:

Milestone 1: On a quarterly basis, DASA-MP POC sends out call for updates.

Start date: FY23Q1; **End date:** FY25Q4

Milestone 2: On a quarterly basis, Task LOE Leads and OPRs provide current contact for each Task.

Start date: FY23Q1; **End date:** FY25Q4

Task 0.0.b: Adjustments to the MIP

OPR: ASA(M&RA)-SPO; **OCR:** DASA-MP; **Data Owner(s):** All MIP Tasked Organizations

Army People Strategy: Military Implementation Plan 2.0

Write and coordinate the publication of all Fragmentary Orders (FRAGO) as changes to MIP 2.0 are required. Estimated yearly FRAGOs timed to sync with Program Objective Memorandum (POM) processes.

Task End State: The APS MIP Team and stakeholders have clear and current information about changes to the MIP 2.0 EXORD and who to contact for any question or action.

Dependencies: Task 0.0.a: Update Point of Contact (POC) lists, requested changes sent to SPO from various stakeholders, publication of MIP 2.0 in an EXORD.

Milestones:

Milestone 1: On a quarterly basis, DASA-MP POC sends out call for modifications to the plan.

Start date: FY23Q1; **End date:** FY25Q4

Milestone 2: FRAGO drafted, approved, and published annually or as needed.

Start date: FY23Q1; **End date:** FY25Q4

Conclusion

The Army People Strategy mission and vision are clear - The Total Army will acquire, develop, employ, and retain Soldiers and DA Civilians of diverse talents needed to achieve Total Army. The vision is to build cohesive teams for the Joint Force by maximizing the talents of our people, the Army's greatest strength and most important weapon system.

Efforts supporting objective areas and tasks/initiatives provide the direction to achieve specific strategic outcomes and build cohesive teams for the Joint Force that are ready, professional, diverse, and integrated.

This plan is both schedule- and data-driven. It identifies gaps, implements solutions, and measures improvements so we can assess progress and build upon it in effective ways. At a minimum, a task should include a clear, concise description, an explanation of activities that need to occur along a timeline, metrics for success, resource requirements or changes, and the end-state.

This plan highlights the Secretary's force objectives, strategic focus, and threats to the force.

Ensuring the plan addresses areas that were previously set aside as annexes, critical enablers, or not previously considered enables greater unity of effort, progress tracking, and reporting.

Tasks in this plan call out specific milestones for Fiscal Years (FY) 23-25. Performance measures are tied to effectiveness, dollar savings, time-savings, or performance.

Army People Strategy: Military Implementation Plan 2.0

MIP 2.0 serves as the foundation for all Army readiness, modernization, and reform efforts. The plan builds on the Army's readiness by identifying gaps, implementing solutions, and measuring improvements so that the Army can assess its progress and alter its course as necessary. Through the MIP 2.0, the Army will be better positioned to compete for the diverse talent it needs, develop its Soldiers to their fullest extent, employ the full range of their capabilities, and retain their experience for the future.

This is not a small effort. Content for this plan is sourced from the ASA(M&RA), Deputy Chief of Staff (DCS) G-1, and TRADOC; input comes from organizations ranging from the Office of the Chief of Chaplains to the Centers of Excellence, from the Army Enterprise Marketing Office to DCS G-9. Execution of this plan will be as broad as its compilation. Through this effort, the Army will be better poised to create the Army of 2030 in a sustainable, inclusive, and supportive environment that lets Soldiers perform to their greatest potential.



**Chapter 1: Address the Secretary of the
Army's Objectives**

Military Implementation Plan 2.0

Army People Strategy: Military Implementation Plan 2.0

Address the Secretary of the Army's Objectives

The Secretary of the Army detailed six objectives on 8 February 2022. In subsequent messaging dated 7 April 2022, the Secretary highlighted six objectives and charged the Under Secretary with developing an implementation plan for each. This document addresses several of these objectives. Given that many initiatives are cross-cutting, they do not all bin neatly within an objective. For example, selecting the right leaders through the Command Assessment Program is critical to "building positive command climates at scale," but listed under "identify talent." The highlights of how each objective will be addressed are indicated here, but this should not be taken as an exhaustive list. In particular, given the well-established relationship between positive command climates and the reduction in harmful behaviors, as well as the scope of such efforts within the Army, Objectives 4 and 5 will also be included in the Army Campaign Plan with additional implementation documents pending.

- 1) Objective One: Putting the Army on a sustainable strategic path.
 - The Army Recruiting and Retention Task Force (ARTF) supports the SECARMY's first objective.

- 2) Objective Two: Ensuring the Army becomes more data centric and can operate in contested environments.
 - Within Chapter 5: Employ Talent, much of Objective 5.1: Identify Talent and Objective 5.2: Align Talent are focused on adding Soldier assessments, collecting more and better talent data about people, and learning how to use that knowledge to better align particular people with particular positions.
 - Chapter 11: People Analytics – the underpinnings of people analytics are the data we have about people and their behaviors. Work is also ongoing to expand how that ever-growing set of data can be used.
 - Throughout the MIP and the People Enterprise are mentions of the IPPS-A (Chapter 2, Tasks 4.1.f, 5.1.c, 5.1.d, 5.2.b, 5.3.c, 6.3.a, 6.3.b, Chapter 11, and Task 12.1.a) and Accessions Information Environment (AIE) (Tasks 3.1.e, 3.2.c, 3.2.c1) systems. Both will help collect data to better serve People and make data-driven decisions.

- 3) Objective Three: Continuing efforts to be resilient in the face of climate change.
No initiatives applicable to this objective.

- 4) Objective Four: Building positive command climate at scale.
 - Chapter 7: Advance Diversity, Equity, Inclusion, and Accessibility – one of the main goals of the Diversity, Equity, Inclusion, and Accessibility (DEIA) program is to build a more inclusive, welcoming Army that values its people of all kinds.
 - Chapter 10: Holistic Health & Fitness – embracing physical, mental, and spiritual health builds ready Soldiers with positive mindsets.

Army People Strategy: Military Implementation Plan 2.0

- Counter-Insider Threat (C-InT): Ongoing and expanding efforts to screen personnel for indications of insider threat behaviors are intended to increase safety, improve overall command climate, and reduce harmful behaviors, supporting Objectives 4 and 5. Conducting proper screening of civilian and military personnel before entry to Army or to specified positions, and after entry to Army, ensures reduction of risk to Total Army Workforce and improves safety and command climate. Risk reduction extends beyond workforce in form of families, networks, information, and infrastructure. Current actions supporting C-InT; is through support of G-3/5/7 C-InT Army Protection Program Assessment (APPA) staff assistance visits to Army Commands, Major Commands, Army Service Component Commands, Direct Report Units, and Field Operating Agencies on their holistic protection program; Co-chair to Army C-InT Working Group for initiatives and programs to protect the Army; conducting suitability adjudication at the Centralized Suitability Service Center for civilian applicants' ability for employment based on multiple factors and considerations; and screening military personnel by Human Resources Command for specified positions throughout the Army as outlined in Army Directive 2018-16, Specified Positions. Actions support other agencies in countering Insider Threats for the Army and Department of Defense.
 - Improved installations and Quality of Life (QOL) services contribute to positive command climates, and are addressed in Chapter 2: Care for Soldiers, DA Civilians, and Families.
- 5) Objective Five: Reduce harmful behaviors in the Army.
- Chapter 8: Build Resiliency – Resiliency programs provide Soldiers, DA Civilians, and Army Families tools to deal with stressors in positive ways and reduce behaviors like substance abuse and suicide.
 - Chapter 9: Sexual Harassment/Assault Response and Prevention (SHARP) – The SHARP program works to address issues of sexual harassment and assault, through preventing behaviors and supporting of victims.
 - The Army Integrated Prevention Strategy (AIPS) develops a single strategy for primary prevention across the spectrum of harmful behaviors, and is addressed in Chapter 2: Care for Soldiers, DA Civilians, and Families.
 - The Integrated Prevention Advisory Group (IPAG) (referred to at the DOD level as the Prevention Workforce (PWF)) is a developing group of personnel whose jobs will involve planning, measuring, and implementing primary prevention strategies and is addressed in Chapter 2: Care for Soldiers, DA Civilians, and Families.
- 6) Objective Six: Strategically adapt the way we recruit and retain talent into the Army to sustain the all-volunteer force.
- Chapter 3: Acquire Talent is focused on competing for new talent. In particular, Objective 3.1: Market the Army is focused on marketing, which plays a critical role in attracting talent to the Army. Key advancements in who we message to, how, when, and what exactly that messaging is will allow us to adapt to today's youth and draw them to the Army. Objective 3.2: Recruit the Army is focused on

Army People Strategy: Military Implementation Plan 2.0

recruiting, i.e. causing a prospective recruit to volunteer for service. New and redoubled efforts to recruit for the Army National Guard, enhance testing, and improve information systems that are critical recruiting infrastructure are all included.

- Chapter 6: Retain Talent is focused on retention of Army talent in active or reserve service and supporting transition to civilian life. Some relatively new concepts in this space include increasing permeability between the Army's Components and efforts to modernize first term enlisted retention.
- The Army Recruiting and Retention Task Force (ARTF) was established in direct response to the SECARMY's sixth objective.

Army Recruiting and Retention Task Force (ARTF)

The Secretary of the Army established the Army Recruiting and Retention Task Force (ARTF) on 04 August 2022 to analyze the recruiting and retention environment and develop solutions to meet the Total Army's current and future end-strength goals. This task force directly supports the Secretary's first and sixth objectives in her 08 February 2022 message to the force, "put the Army on a sustainable strategic path" and "strategically adapt the way we recruit and retain talent into the Army in order to sustain the all-volunteer force" as well as the Chief of Staff of the Army's #1 priority: People.

The ARTF will focus on generating actionable recommendations on a rolling basis to enable near-term results, while also thinking long-term to enable recruiting and retention for years to come. To accomplish these tasks, the task force will have a wide aperture covering everything from the process of how the Army recruits and retains on an annual basis, but also more broadly on how the Army builds propensity and expands the percentage of prospective Soldiers eligible to serve beyond the current 23% of Americans.



**Chapter 2: Care for Soldiers, DA Civilians,
and Families**

Military Implementation Plan 2.0

Army People Strategy: Military Implementation Plan 2.0

Care for Soldiers, DA Civilians, and Families

Develop Leaders

APS LOE 2 (See Chapter 4: Develop Talent) – Develop Talent is squarely focused on developing Soldiers and future leaders. In particular, Objective 4.1: Educate the Army and Objective 4.2: Train the Army incorporates numerous updates to how we educate, train, and support the development of Soldiers.

In addition, some aspects of LOE 3 – Employ Talent (see Chapter 5: Employ Talent) addresses identifying the talents of Soldiers and future leaders, aligning individuals with jobs to best make use of those talents, and promoting to recognize performance and select talented individuals into positions of greater responsibility.

Build Positive Command Climates

The Diversity, Equity, Inclusion, and Accessibility program develops a welcoming Army that values people of all kind and builds a positive environment of inclusion (see Chapter 7: Advance Diversity, Equity, Inclusion, and Accessibility).

The Holistic Health and Fitness system demonstrates how embracing physical, mental, and spiritual health improves Soldier readiness through positive mindsets (see Chapter 10: Holistic Health & Fitness).

Mission Essential Condition (MEC) and Quarterly People and Training Brief (QPTB)

OPR: PFTF; **OCR:** ASA(M&RA)-E&I

Description: Healthy command climates are essential to who we are and how well we fight. They underpin the effectiveness and endurance in operations. The Army's readiness assessments, however, presently accommodate a 'trained' rating largely removed from the consideration of command climate. To close this gap, the People First Task Force (PFTF) has worked closely with the Mission Command Center of Excellence and other stakeholders to develop a concept for a MEC entitled "Build Cohesive Teams."

The MEC is a derivation of a traditional Mission Essential Task (MET) that applies to the Total Force. Its evaluative criteria are delineated in Training and Evaluation Outline (T&EO)-like 'Indicator Outlines' that are tied to protective factors and encapsulate existing regulatory guidance and doctrine. This approach prompts commanders to have command climate-related discussions with leaders, while better operationalizing 'People First' concepts. The MEC is congruent with Strategic Readiness Tenet #5 (Leading), informs Unit Status Reports (USR) without changing the current algorithm, and serves as an input to an evolved Quarterly People and Training Brief (QPTB). The QPTB is an evolution of the more traditional Quarterly Training Brief (QTB) and is designed to provide a structured but candid discussion between commanders. This structured discussion serves to facilitate agreement on the current state of readiness, the way forward, necessary resources, and the risk involved in their approach. The QPTB leverages tools, such as Command Climate Assessments and the Center for the Army

Army People Strategy: Military Implementation Plan 2.0

Profession & Leadership's Command Climate Navigator, which accommodates the development of action plans, to support these discussions.

The end state for both the MEC and the QPTB is to bring command climate to the forefront of the commander-to-commander dialogue at echelon and address the human element of combat readiness.

Timeframe:

Staff and publish EXORD in 4th quarter FY22 to initiate pilot in 1st quarter FY23 with end-of-pilot assessment in 4th quarter FY23.

Decision on Army-wide implementation no later than 1st quarter FY24.

Sexual Harassment and Sexual Assault Fusion Directorate Pilot Program

OPR: ARD; **OCR:** PFTF

Description: Following the Fort Hood Independent Review Committee (FHIRC) report, the CSA directed the People First Task Force (PFTF) to evaluate the Army's Sexual Harassment/Assault Response and Prevention (SHARP) program. This analysis resulted in recommendations to implement major structural changes to the Sexual Harassment/Sexual Assault (SH/SA) program. These recommendations include piloting a multi-disciplinary SH/SA Fusion Directorate under the oversight of the installation senior commander.

The Army launched a one-year Fusion Directorate pilot of a new approach for caring for, protecting, and empowering victims/survivors of sexual harassment and assault at six Active Component installations (Aberdeen Proving Ground, Schofield Barracks, and Forts Bragg, Irwin, Riley, and Sill) and one Army Reserve Regional Readiness Division (Fort Dix, NJ). These directorates consolidate management of all installation sexual assault response coordinators and victim advocates and will be supervised by an experienced senior advocate. They will also be centrally managed to support designated units and general installation requirements. These professionals remain aligned to their units to ensure they are familiar with the mission and climate. Under this system, they are also positioned to advise the commander's execution of the SHARP program and support personnel who need victim care and services. The presence of response elements (CID, JAG, Chaplains, BH) is also enhanced within the Fusion Directorates to increase their flexibility and provide for the comfort of the complainant or victim.

Additionally, the PFTF was directed by Army Senior Leadership (ASL) to initiate the development of a mobile application that would enable Soldiers to immediately notify emergency assistance via Global Positioning System (GPS) in the event of a sexual assault or attempt. The identified need of the primary demographic (junior enlisted ages 18-24) is assistance in understanding what has happened to them; thinking about the assistance and outcomes they need/want; considering reporting options based on their experience, needs, and preferences; and helping them get in touch with an advocate or service provider if they choose. The PFTF has been working directly with Army Futures

Army People Strategy: Military Implementation Plan 2.0

Command's Software Factory to develop the "Lighthouse" application since October 2021 and will initiate a usability test for the application to capture user feedback on their experience of the product with select brigades at Fort Bragg and Fort Sill in July 2022, in preparation for further development. Fusion Directorate is a victim-centered model which aims to increase accountability, transparency, and efficiency by coordinating medical, investigative, legal, and support services through a single directorate to maximize efforts and keep victims better informed.

Timeframe:

Pilot announced and EXORD published Oct 2021.

Six active component Fusion Directorate locations were launched in April 2022 and one United States Army Reserve (USAR) pilot will launch in July 2022.

Lighthouse Application Usability Pilot to launch in July 2022

Assessment of the concurrent pilots April 2022-April 2023

Decision on Army-wide implementation To Be Determined (TBD).

Cohesion Assessment Team (CAT)

OPR: TRADOC; **OCR:** PFTF, ASA(M&RA)-E&I

Description: In February 2021, the CSA directed the development of a team of experienced leaders and subject matter experts to provide commanders at brigade and below an assessment of their units' trust and cohesion. The team is comprised of 22 members consisting of operational leaders (officers and senior enlisted), research psychologists, sexual assault response professionals, legal advisors, chaplains, prevention specialists and organizational behavior experts. Currently, the Army staffs CATs using nominations from the force that are built around a People First Task Force cadre. The program will be transitioning to TRADOC control by January 2023. Details of this transition are contained in an EXORD titled Transfer of Cohesion Assessment Team From the People First Task Force to Training and Doctrine Command.

Anchored by an operational framework to remove bias, the CAT informs commanders of potential blind spots, provides actionable feedback, best practices, and tools to assist in action planning. Its assessment follows an ordered, science-driven approach to look at the culture and dynamics of each individual unit. The team considers and analyzes a wide array of existing Army metrics and on-line survey data accompanied by personal observations, focus groups, and interviews with leaders and support personnel. The 10-day CAT organizational assessment assesses the effectiveness of a unit's leadership, structure, mission and strategy, processes, culture, environment, rewards, and utilization of leader programs to build trust, cohesion, and readiness. To date, the CAT has completed six assessments of Regular Army brigades located at Fort Stewart, Fort Carson, Korea, Joint Base Lewis-McCord, Fort Hood and Fort Wainwright.

Army People Strategy: Military Implementation Plan 2.0

Secretary Wormuth announced the Army will institutionalize the CAT capability no later than January 2023. The PFTF is currently working with TRADOC to transition responsibility of the CAT by this deadline.

The end state for the CAT remains to provide commanders at echelon both specific, prioritized, actionable recommendations regarding their climate and tools to assist in the development of action plans.

Timeframe:

TRADOC assumes CAT; Initial Operational Capability 01 OCT 2022

TRADOC Full Operational Capability no later than JAN 2023

Prevent/Reduce Harmful Behaviors

The SHARP program works to address sexual harassment and assault issues by preventing harmful behaviors and supporting of victims (see Chapter 9: Sexual Harassment/Assault Response and Prevention).

Resiliency programs provide Soldiers, DA Civilians, and Army Families tools to deal with stressors in positive ways and reduce harmful behaviors like substance abuse and suicide (see Chapter 8: Build Resiliency).

Additionally, the People First Task Force is drafting an Army Integrated Prevention Strategy (AIPS) that is described below, and working toward implementing the recommendations made by the Fort Hood Independent Review Committee. Moreover, the Office of the Provost Marshal General (OPMG) is reinvigorating the Army Crime Prevention Program that increases interoperability between the multidisciplinary domains within the AIPS. Given the well-established relationships between positive command climates, law enforcement, and the reduction in harmful behaviors, we embrace the need to treat healthy organizational climates as a baseline condition to readiness and the necessity to modernize the Army's prevention system. These collective efforts remain aligned and responsive to the recommendations and guidance from the Secretary of Defense directed 90-day Independent Review Commission (IRC) to address sexual assault and harassment in the force, and in anticipation of the recently ordered Suicide Prevention (SP) and Response Independent Review Committee (SPRIRC).

Army Integrated Prevention Strategy (AIPS)

OPR: PFTF; **OCR:** ASA(M&RA), ARD

Description: In September 2021, the Secretary of the Army directed the development of a coherent strategy to prevent harmful behaviors within the force. Consistent with DoD's renewed focus on prevention, the *Army Integrated Prevention Strategy (AIPS)* establishes both coherency and unity of effort within the prevention space. It incorporates key findings and tasks from recent reviews including the Independent Review Commission (IRC) on Sexual Assault in the Military, the Fort Hood Independent

Army People Strategy: Military Implementation Plan 2.0

Review Committee, On-Site Installation Evaluations, and the DoD Prevention Plan of Action 2.0. The AIPS sets the conditions for rapid implementation of future findings from committees and reviews. It also creates the necessary framework to develop, oversee, and modernize the prevention system and its components; provides processes for accountability; and accounts for how the Army will institutionalize and operationalize prevention.

The AIPS further provides a framework through which the Army establishes layered prevention systems within organizations, installations, and communities, and at HQDA. The future prevention system is intended to:

- Align authorities and responsibilities in a way that provides coherence
- Provide commanders and leaders the tools, training and capabilities needed to create lasting change
- Strengthen oversight of prevention infrastructure and execution
- Center on addressing shared individual and collective risk and protective factors
- Foster supportive environments
- Adapt to the impacts of an ever-changing social environment
- Expand prevention activities across the prevention continuum, with an emphasis toward “upstream,” primary prevention efforts
- Support positive command climates at scale
- Leverage data and research to ensure accountability, focus efforts, drive continuous improvement and innovation

The end state for the AIPS is a unified, coherent approach to integrated prevention that reduces harmful behaviors. These will be achieved through three goals, (1) establish prevention infrastructure, (2) execute primary prevention, and (3) become a learning organization optimized for prevention.

Timeframe:

Once approved by the Secretary of the Army, the next step will be the development of an implementation plan with anticipated activities through FY27.

The Prevention Workforce (PWF) and the Integrated Prevention Advisory Group (IPAG)

OPR: Army Resiliency Directorate (ARD); **OCR:** ASA(M&RA), PFTF

The Prevention Workforce represents an essential element of a prevention system. This workforce will work collaboratively with existing prevention programs to develop integrated prevention strategies and activities for Army Senior Leaders and responsible commanders based on the unique needs and conditions of the organization and community. The recruitment and retention of a professional and dedicated Integrated Prevention Advisory Group (IPAG) enables commanders to execute the Army Integrated Prevention Strategy (AIPS) by providing the technical expertise to link the science of

Army People Strategy: Military Implementation Plan 2.0

prevention and the art of command within an optimized prevention system. This workforce is additive and does not replace existing program specific prevention personnel. The dedicated IPAG will be the Army's critical enabler to ensure the integrated prevention process is expert informed and data driven in support of commanders.

In general, the IPAG will develop strategies and implement research based primary prevention activities to mitigate risk factors and promote protective factors within Army Communities. They will do this using the DOD four step prevention process.

1. Understand the problem
2. Develop a comprehensive approach
3. Ensure quality implementation
4. Continuously evaluate efforts

At every echelon, the IPAG will develop and measure process- and outcomes-based metrics to assess the effectiveness of prevention activities and share this information with commanders and leaders. This will assist in planning and decision-making for the enduring allocation of prevention resources. The DoD Policy on Integrated Primary Prevention of Self-Directed Harm and Prohibited Abuse or Harm (Department of Defense Instruction) (DoDI) 6400.09) identifies that, at a minimum, PWF professionals will be able to:

- Describe and explain how harmful behaviors are a social and public health problem
- Apply prevention science to military context
- Access, interpret, use, and present data on harmful behaviors and the factors that contribute to those behaviors
- Design, adapt, and implement integrated primary prevention activities
- Conduct public health evaluations to determine effectiveness of integrated primary prevention activities
- Build and manage an integrated primary prevention program that will disseminate information to and collaborate with the community, other professionals, key policymakers, and leaders
- Build the prevention capacity of the military community through outreach and education
- Stimulate change through improvement of policies, programs, and practices
- Maintain and develop their own competency as a prevention professional.

The OSD requirement to hire a dedicated full-time prevention workforce supports the Army People Strategy objectives to recruit, retain, and sustain a highly skilled workforce and prevent/reduce harmful behaviors. The Integrated Prevention Advisory Group (IPAG) will be operationalized across four LOEs: LOE 1: Prevention Workforce Planning Assessment; LOE 2: Initial Implementation Plan; LOE 3: Manning Development and Analysis; and LOE 4: Full Operating Capacity and Sustainment. In LOE 1 data collected

Army People Strategy: Military Implementation Plan 2.0

will be used to determine the number of prevention personnel needed, and potential risks to implementation. Initial operating concept will start in LOE 2; as implementation begins lessons learned will be gathered to inform full operating capability (FOC; FY 23-27). LOE 3 will determine the size of the workforce needed to sustain the ability to reduce harmful behaviors. Finally, the purpose of LOE 4 is to 1) hire and train the I-PAG as denoted by the updated implementation plan developed in LOE 1, 2) work collaboratively with other Army organizations to create the guidance documents required to support the IPAG, and 3) codify the prevention system and process within the Army.

Timeframe:

The Army will begin to establish the dedicated prevention workforce capability in a phased approach, beginning with Phase 1 (12 months) in late Fiscal Year 2022 across five select installations, select Army Commands, and the Headquarters Department of the Army (HQDA). Phase 1 implementation will inform how the IPAG is employed at echelon; validate the workforce's required knowledge, skills, and abilities; and determine optimal scaling across the Army. Phase 1 implementation will provide necessary insight for how the IPAG will integrate with existing prevention personnel and assets, across levels of command, and within military units. Specific Phase 1 implementation objectives, to include detailed IPAG roles and responsibilities, implementation requirements and evaluation criteria are described in the AIPS.

Deliver Installations & Services for Army 2030

Objective 2.1: Installation Support

OPR: DCS G-9; **OCR:** Army Materiel Command (AMC) and appropriate Army stakeholders

The Army wins through its People; they are the Army's greatest strength. Safe operations and adaptable QOL programs for Soldiers and Army Families improve Army readiness and reduce uncertainty. Modern, robust, and efficient facilities, wide availability of training, education, and other services are critical to productively employing and developing Army talent. The Army People Strategy will only succeed with sufficient and trained professionals who provide key services and infrastructure. People promote the Army as a great team to join, and its installations as the best places to work and live. Strong facility conditions, safe operations, wellness services, family programs, and Morale, Welfare, and Recreation (MWR) functions are all essential components to care for people and help the Army compete and win the fight for talent.

The Army priorities remain people, readiness, and modernization. It is People - Soldiers, Army Families, DA Civilians, Retired Soldiers, and Veterans - who will deliver them. People are the Army's greatest strength and we must take care of them. Quality of life (QOL) initiatives appear in both the *Army People Strategy* and the *Army Installation Strategy* to improve the full range of Army care, support, and enrichment programs. QOL efforts provide Soldiers and their families safe housing, accessible and affordable childcare, Family programs, fitness facilities, services, and MWR opportunities.

Army People Strategy: Military Implementation Plan 2.0

The installation enterprise goals and objectives intersect with the Army People Strategy through Army Installations Strategy line of effort (LOE 1), strategic outcome 1, “Attract, Retain, and Enable People,” three strategic objectives, and three strategic level tasks.

Lines of Effort	Strategic Outcomes and Objectives
Take Care of People	Strategic Outcome 1. Attract, Retain, and Enable People
	A. Adapt quality/functional facilities
	B. Deliver modern services
	C. Conduct safe operations

Dependencies: None Identified.

Strategic Objective 2.1A: Adapt Quality/Functional Facilities

The condition of Army facilities - living and working spaces - must attain and maintain the highest quality standards for functionality, quality, resilience, and sustainability. Housing and dining facilities are critical components of Soldiers’ experienced QOL. Similarly, families should have ready access to quality childcare and chapel facilities to accommodate diverse spiritual needs. Ancillary facilities and green spaces that enhance living and work environments - such as walkable development patterns, fitness centers, and recreation areas - contribute to wellness and resilience. The Army must provide quality facilities, whether owned and operated by the Army or shared or leased facilities on or off the installation, that enable the readiness of Soldiers, Army Families, and Department of the Army Civilians in a Multi-Domain Operations (MDO) environment. Efforts will ensure its services and programs are easily accessible, customer focused, data enabled, and protected.

Problem Statement: How should the Army design modern, adaptable, and modular quality of life (QOL) facilities that meet the highest standards for quality and innovation while meeting the needs of the next generations of Soldiers, Army Families and DA Civilians? How can we overcome known barriers and limitations such as funding, statute, legislative, policy, and regulations?

End State: Modern, resilient, sustainable, quality facilities that enable readiness in a contested MDO environment and resilience to climate change impacts.

Approach: Research and Development (R&D) integrated by DCS G-9 Operations Directorate and executed by United States Army Corps of Engineers (USACE). Develop designs for new modernized, modular, adaptable QOL facilities that easily adapt to changing conditions. Incorporate innovative technologies and master planning. (Coordinate with task 3.4)

Strategic Objective 2.1B: Deliver modern services

Installations provide key QOL services and programs that acclimate Soldiers and Army Families into the military community. Future recruits will increasingly come from “smart cities” that streamline the provision of public goods and services in a responsive, user-centric environment. This next generation of potential Soldiers will expect similar levels

Army People Strategy: Military Implementation Plan 2.0

of information, convenience, and choice when it comes to Soldier and Family programs and services offered on an Army installation.

Problem Statement: The Army must adapt and increase QOL program capabilities and capacity to attract and retain future Soldiers, Army Families and DA Civilians.

End State: Easily accessible, customer focused, and sustainable QOL programs and services that enable the readiness of Soldiers, Army Families and DA Civilians in a contested MDO environment.

Approach: Develop modernized and innovative service delivery methods using new technologies; test and adopt new processes and systems. Coordinate with Installations of the Future program. Work with DoD and local communities to provide a broader spectrum of QOL programs and services.

Strategic Objective 2.1C: Conduct Safe Operations

The Total Army expects safe activities and operations on installations. The Army's systematic approach to management and execution of its Safety, Occupational and Environmental Health (SO&EH) program emphasizes using modern SO&EH practices. It also emphasizes leveraging technology systems to better anticipate, recognize, evaluate, and control hazards that pose risks to the people who live, train, work on, and visit installations. Initiatives include implementation of the Army Safety Occupational Health Management System (ASOHMS); increased oversight of Army housing to ensure the most effective and efficient safety, occupational and environmental health services; and establishing or identifying Army centers, laboratories, and commands to explore technologies that will improve risk reduction.

Problem Statement: The Army must ensure installations have the ability to conduct safe operations for Soldiers, Army Families, and DA Civilians, while also being resilient, and MDO ready.

End State: Adequate HQDA Army staff integration that enables a systematic approach for managing and executing the safety, occupational and environmental health program emphasizing modern practices and technology to better anticipate, recognize, evaluate, and control hazards posing risks to people who live, train, work on, and visit Army installations.

Approach: The initial task will entail conducting mission analysis and identifying courses of action for Army Senior Leader approval on establishing the appropriate level of HQDA Army staff integration to include resource integration, for the Army safety program. This is a critical step to enable a successful holistic overhaul of the system and approach to safety, occupational and environmental health in installation operations. Focus will be on institutional and cultural change. Execution will leverage innovative technologies and facility designs, and modernize systems.

Army People Strategy: Military Implementation Plan 2.0

Installation Implementation Tasks						
LOE 1. Take Care of People						
<i>Strategic Objective: 2.1A – Adapt Quality/Functional Facilities</i>						
Sequence #	Task #	Description	Secretariat Oversight	G-9 Integrator	Execution Leads	Target FY to Complete
1	2.1.1	QOL Facility Modernization. Develop new and integrate existing modern and cost-effective facility standards and planning tools for critical QOL-related facilities to meet investment priorities of FY2025.	DASA Installations, Housing, & Partnerships (IH&P)	DAIN-OD	Land Holding Commands and ASCCs	FY25 (for implemented facility standards)
<i>Strategic Objective: 2.1B – Deliver Modern Services</i>						
2	2.1.2	QOL Service Modernization. Determine critical requirements and a Plan of Action and Milestones (POAM) that no later than 2035 that modernizes QOL services at the installations determined by the QOL Task Force.	ASA(M&RA)	DAIN-SF	Land Holding Commands and ASCCs	FY23 (for POAM)
<i>Strategic Objective: 2.1C – Conduct Safe Operations</i>						
3	2.1.3	Army Safety and Occupational Health integration. Determine and establish the appropriate level of HQDA ARSTAF integration required to implement, no later than FY28, the Army Safety and Occupational Health Management System (ASOHMS).	DASA Environment Safety, & Occupational Health (ESOH)	DAIN-ZSI	ESOH	FY23 – HQDA integration established FY28 – ASOHMS implemented

Objective Measures of Effectiveness and Performance:

- Percentage of facility standards implemented by end of FY25 (goal: **100%**)
- Percentage of critical service modernization requirements complete by end of FY23 (goal: **100%**)
- Measure impact of QOL facility modernization on recruitment and retention (trend analysis goal: **increase**)
- Measure impact of QOL service modernization on recruitment and retention (trend analysis goal: **increase**)
- Measure change in safety and occupational and environmental health issues (trend analysis goal: **decrease**)
- Measure change in ASOHMS implementation (trend analysis goal: **increase**, toward 100% implementation by FY28)

Army People Strategy: Military Implementation Plan 2.0

Deliver Army Quality-of-Life Programs and Services

Army Quality of Life (QOL) includes the full range of Army care, support, and enrichment programs intended to enhance and maintain the readiness of its Soldiers, Civilians, and their families in line with the Army People Strategy (APS). QOL ensures the foundation for a long-term partnership between the Army, its Soldiers, Civilians, and their Families, is mutually beneficial and satisfying.

The APS mission is to *acquire, develop, employ, and retain the diversity of Soldier and Civilian talent needed to achieve Total Army readiness*. The APS vision is to build cohesive teams for the Joint Force by maximizing the talents of people, the Army's greatest strength and most important weapon system. Effective, efficient, and well-executed QOL programs increase health and wellbeing. They reduce stress, absenteeism, disengagement, and rework and retraining expenses, thus driving down overall labor costs and increasing Total Army readiness. Exceptional Soldier and Civilian support programs also engender trust between the Army and its professionals, simultaneously improving talent acquisition and retention efforts. Given the demands made upon military and civilian professionals, we owe them the best quality of life services possible.

Improved QOL programs attract and retain quality personnel. QOL programs improve retention, as Soldiers and Family members reap the benefits of quality housing and healthcare, quality, affordable child care and youth programs, spouse career and employment opportunities, an improved permanent change of station move experience, and support and resilience (e.g. support to designated remote and isolated installations, promoting MWR programs with predictable Army Community Service programming, development of digital applications, and spiritual revitalization efforts).

By 2030, the desired end-state is effective, efficient, and well-executed QOL programs that ensure the health and well-being of Army people, reduce stress, and increase recruiting and retention in support of overall Army Readiness.

Objective 2.2: Execute QOL Campaign Plan

To strengthen QOL programs, the Secretary of the Army established a QOL Task Force charged with developing a campaign plan nested within the Army People Strategy with an initial focus on housing, healthcare, child care, spouse employment, and permanent change of station moves, with additional emphasis on installations identified by Army Senior Leaders as high priority for solutions. In addition, this implementation plan includes a comprehensive holistic review of all Army QOL programs which will identify gaps and overlapping programs across the full range of Army care, support, and enrichment programs and provide recommendations to Senior Leaders on each program.

Key Tasks:

Task 2.2.a: Housing and Barracks

OPR: ASA (IE&E); **OCR:** DCS G-9

Army People Strategy: Military Implementation Plan 2.0

Army leaders are committed to improving housing conditions. The Army will accomplish the following objectives and supporting tasks to improve housing and the quality of life for Soldiers and Army Families. The Army will establish effective policy and framework that sets strategic direction and expectations for effective processes, procedures, and oversight of housing at every echelon. The Army will develop high quality, safe and habitable housing in welcoming communities that provides service members and Army Families with desirable, modernized and flexible living conditions. We must ensure effective command execution and accountability of established policies, processes, procedures, and oversight of housing to provide quality housing for Service Members and their families. The Army will conduct regular town hall meetings to discuss resident issues and concerns, fully implement the Tenant Bill of Rights at all RCI project locations, and annually assess tenant satisfaction for all housing types.

Task End State: Ensure installation housing is the home of choice for Soldiers and Army Families.

Dependencies: None Identified.

Task Measures of Effectiveness and Performance:

- Improve oversight and accountability (1.1.)
- Develop holistic housing investment strategy (1.2.)
- Develop holistic education strategies (1.3.)
- Improve customer service (1.4.)

Milestones:

Milestone 1: Continue Army Housing Campaign Plan execution to shape policies, procedures, and processes at every echelon including FY20/21/22 NDAA Provision Implementation.

Start Date: FY20Q1; **End Date:** FY23Q1

Milestone 2: Publish Tenant Bill of Rights (TBoRs) implemented at 44 privatized housing installations (complete).

Start Date: FY20Q1; **End Date:** FY22Q1

Milestone 3: Implement standard Housing Maintenance Quality Assurance & Environmental Hazard Oversight Program inspection checklist for all housing types (complete).

Start Date: FY20Q1; **End Date:** FY22Q2

Milestone 4: Invest \$1.5B in FY23-27 to construct new, improve, demolish, and repair Army Family Housing achieving 89% Q1/Q2 rating across the housing inventory.

Start Date: FY20Q1; **End Date:** FY27Q4

Army People Strategy: Military Implementation Plan 2.0

Milestone 5: Improve Barracks through a strategy to invest approximately \$10B FY21-30 across all three Components.

Start Date: FY20Q1; **End Date:** FY30Q4

Milestone 6: Publish the revised Army Standard for permanent party barracks (E1-E6) (complete).

Start Date: FY20Q1; **End Date:** FY22Q1

Milestone 7: Publish Tenant Satisfaction Survey (complete).

Start Date: FY22Q1; **End Date:** FY22Q3

Task 2.2.b: Healthcare

OPR: OTSG; **OCR:** DCS G-9

Army Medicine's primary mission is to support the Total Force by enabling readiness and conserving the fighting strength while caring for people and their Army Families. Key tasks include improving access to health/dental care; referral utilization capabilities; enhancing Tricare Online Patient Portal (TOLPP) applications; and partnering with Defense Health Agency (DHA) to transition healthcare delivery to the agency creating an integrated military medical health system. We must strive to enhance awareness of installation healthcare resources and conduct Army Family health surveillance activities using the Community Strengths Themes Assessment (CSTA) and Military Nutrition Environmental Assessment Tool (mNEAT). The Army will facilitate access to effective behavioral health care through synergetic coordination with DHA; monitor the effectiveness of the unit Embedded Behavioral Health (EBH) Programs; assess Installation Director of Psychological Health (IDPH) engagement on the Commander's Ready and Resilient Council (CR2C). Leverage Holistic Health and Fitness (H2F) systems and continue to support the Army Wellness Centers (AWC). We will leverage existing and emerging technology to enhance virtual health platforms increasing access to care particularly in remote locations.

Task End State: A more integrated, efficient, and effective healthcare system.

Dependencies: None Identified.

Task Measures of Effectiveness and Performance:

- Facilitate access to safe, high-quality healthcare (2.1.)
- Promote Soldier/Family Relations (2.2.)
- Facilitate Behavioral Health System of Care (2.3.)
- Promote Soldier and Family Readiness (2.4.)
- Proliferate Technology (2.5.)

Army People Strategy: Military Implementation Plan 2.0

Milestones:

Milestone 1: Ensure leader satisfaction in being able to meet the needs of unit's Soldiers. OTSG Behavioral Health Division coordinating with DHA BH leads to conduct another leader survey in fall 2022 to ensure the Embedded Behavior Health (EBH) Program is meeting BH needs of Soldiers and unit leaders.

Start Date: FY20Q1; **End Date:** FY23Q1

Milestone 2: Execute Total Army Family Health Monitoring and Surveillance Activities (Community Strengths and Themes Assessment (CSTA), Military Nutrition Environmental Assessment Tool (mNEAT), Health of the Army Family (HOAF)).

Start Date: FY20Q1; **End Date:** FY24Q1

Milestone 3: Monitor FY24 Dental and Authority to Hire Veterans Legislative Proposal submission through HQDA for SA/CSA endorsement. Gain congressional approval of the dental legislative proposal (ASL).

Start Date: FY21Q1; **End Date:** FY24Q1

Milestone 4: Transition legacy systems to MHS GENESIS.

Start Date: FY20Q1; **End Date:** FY24Q4

Task 2.2.c: Child Care

OPR: ASA(M&RA)-QOL; **OCR:** DCS G-9

Army leaders are committed to ensuring Soldiers and their Army Families have access to affordable, quality child care to reduce the conflict between parental obligations and mission requirements. Increasing access to child care is a major effort in the Army's QOL Task Force. Reducing wait lists and wait times for child care, increasing the number of Family Child Care (FCC) homes, funding the Fee Assistance Program, Reserve Component Weekend Drill and Annual Training Child Care, and recruiting and retaining child care personnel are all critical elements to ensure availability of care.

The Army will build and maintain the additional child care facilities needed to increase availability of care. We must monitor the progress of constructing the CDCs in the NDAA 22 and the restoration or modernization of the Child and Youth Services (CYS) facilities listed as failing or in poor condition in the Facility Investment Plan (FIP). Army leaders will continue to fully implement the updated child care access priorities and track/monitor supplanting efforts. The Army is committed to maintaining onboard staffing at 90% or higher by improving staff compensation and benefits. In addition, the Army will ensure the Army Fee Assistance (AFA) program meets the needs of military families who are geographically dispersed or where there are long waiting lists for care on the installation. Lastly, the Army will monitor the access military children have to quality education regardless of their location.

Task End State: Quality, affordable, and predictable child and youth programs.

Army People Strategy: Military Implementation Plan 2.0

Dependencies: None Identified.

Task Measures of Effectiveness and Performance:

- Increase access to and decrease wait times for child development centers (CDCs) (3.1.)
- Increase number of FCC providers (On and Off Post) (3.2.)
- Recruit and Retain Child Care Providers (3.3.)
- Conduct holistic review of Army Fee Asst. Program (3.4.)

Milestones:

Milestone 1: Program and construct 21 additional CDCs for an additional ~4,300 childcare spaces.

Start Date: FY20Q1; **End Date:** FY24Q4

Milestone 2: Develop strategy to sustain FCC growth.

Start Date: FY20Q1; **End Date:** FY24Q1

Milestone 3: Implement Department of Defense revised classification and pay system for child development program staff.

Start Date: FY24Q1; **End Date:** FY24Q4

Milestone 4: Evaluate compensation and other options (e.g., tuition assistance, student loan forgiveness, benefits for flex employees) to stabilize CYS workforce.

Start Date: FY20Q1; **End Date:** FY22Q4

Milestone 5: Evaluate eligibility and placement priorities for patron access to AFA and publish updated policy and fee guidance for Army Fee Assistance.

Start Date: FY20Q1; **End Date:** FY22Q1

Milestone 6: Implement pilots to extend weekend childcare to Components 2 and 3.

Start Date: FY23Q1; **End Date:** FY25Q4

Task 2.2.d: Spouse Employment

OPR: ASA(M&RA)-QOL; **OCR:** DCS G-9

The Army and DoD are improving career and employment opportunities for military spouses. The Army will reduce Army spouse unemployment by 5% and increase the number of Army spouses using My Career Advancement Accounts (MyCAA) by 10%. We will do this by providing support to Soldiers and Army Families, so they are fully educated on the resources available to enhance employment opportunities and continue to improve policies that reduce unemployment and underemployment rates.

Task End State: Improve career and employment opportunities for Army spouses.

Army People Strategy: Military Implementation Plan 2.0

Dependencies: None Identified.

Task Measures of Effectiveness and Performance:

- Reduce spouse unemployment/underemployment (4.1.)
- Promote use of My Career Advancement Accounts (DoD) (4.2.)
- Improve Army employment information and resources (4.3.)
- Expand use of spouse preference and non-competitive hire authority for spouses (4.4.)
- Simplify home-based business applications (4.5.)
- Develop long-term metrics to determine efficacy of spouse employment programs on Soldier retention and improve data collection in support of long-term outcomes (4.6.)

Milestones:

Milestone 1: Develop voluntary Army-wide reassignment program for APF employees. Program will enable Army-wide support to eligible Military Spouses currently employed as Army Civilians seeking to retain employment during PCS moves.

Start Date: FY20Q1; **End Date:** FY23Q4

Milestone 2: Explore solutions for synchronizing DoD efforts when marketing My Career Advancement Account (MyCAA)

Start Date: FY20Q1; **End Date:** FY23Q4

Milestone 3: Determine the source of record for data related to spouse unemployment and underemployment

Start Date: FY20Q1; **End Date:** FY24Q4

Milestone 4: Simplify home-based business applications.

Start Date: FY23Q1; **End Date:** FY23 Q2

Milestone 5: Develop long-term metrics that show the efficacy of spouse employment programs on Soldier retention.

Start Date: FY20Q1; **End Date:** FY24Q4

Milestone 6: Identify relevant data and improve data collection relevant to long-term outcomes.

Start Date: FY23Q1; **End Date:** FY23Q2

Task 2.2.e: Permanent Change of Station (PCS) Moves

OPR: ASA(M&RA)-QOL; **OCR:** DCS G-4

The Army continues to make great strides to improve the PCS and household goods (HHG) experience. The Army will increase Soldier awareness of entitlements and

Army People Strategy: Military Implementation Plan 2.0

policies relative to Permanent Change of Station, move type, locations, and family accompaniment. Using videos, applications, and metric data we will work with all stakeholders for the most up to date information and way ahead. We will work to provide support to Soldiers and Army Families, so they are fully educated on the resources available to enhance their moves. Leverage modern technologies with the web and personal device availability to allow Soldiers/Army Families to access HHG status and information to aid in managing their move(s). Develop a smart process of capturing significant data that will quickly point analysts, policy makers, and action officers to areas of necessary focus for corrective actions.

Task End State: Provide predictable and responsive services and support.

Dependencies: None Identified.

Task Measures of Effectiveness and Performance:

- Improve HHG Entitlements and Policies (5.1.)
- Increase lead-time for PCS Orders (120 days or more) (5.2.)
- Implement standards-based QA inspections (5.3.)
- Develop application(s) that allow customers to track HHGs (5.4.)
- Train and educate the force about entitlements and policies (5.5.)
- Develop metrics and common operating picture (5.6.)

Milestones:

Milestone 1: Increase HHG weight allowance for specific grades.

Start Date: FY20Q1; **End Date:** FY23Q4

Milestone 2: Allow more time to make the final move after retirement (remove requirement to request annual extensions above the 12-month initial allowance period).

Start Date: FY20Q1; **End Date:** FY23Q1

Milestone 3: Provide status updates on location of household goods; arrival/departure from transition points or storage location.

Start Date: FY20Q1; **End Date:** FY23Q4

Milestone 4: Incorporate QA inspections in measurable tool (e.g., ISR reporting) (complete).

Start Date: FY20Q1; **End Date:** FY22Q1

Task 2.2.f: Support and Resilience

OPR: ASA(M&RA); **OCR:** DCS G-9, DCS G-1

The Army emphasizes the QOL for Soldiers and Army Families at installations with critical needs such as 11th ABN DIV, Fort Polk, Fort Irwin, and Fort Hood, by connecting them to installation resources, and promoting the Army QOL initiatives throughout the

Army People Strategy: Military Implementation Plan 2.0

enterprise. The Army will provide the highest level of predictable and quality resilience and support programs and capabilities at both remote and austere locations as well as Army-wide based upon Army Senior Leader (ASL) priorities. We must identify gaps and limitations at remote and austere installations prioritized by ASLs to enhance the QOL at the installations identified by ASLs. Initial emphasis will be placed at Alaska, Fort Polk, Fort Irwin, and Fort Hood. Improvements in ACS service delivery and MWR services and programs across the enterprise and at priority installations identified by ASLs. The Army must develop applications/IT solutions that enhance connection to the resources available at installations along with providing opportunities for further connection. Communicating the “wins” to stakeholders and the public is central in supporting ASL priorities. Active and regular updates in digital media ensures the public and stakeholders see progress in the QOL Task force. Provide scientifically proven increased resiliency by advancing and extending the spiritual community at Fort Polk, Fort Irwin, Fort Hood and Alaska through modern media, resources.

Task End State: Provide the highest level of support at locations that most need it.

Dependencies: None Identified.

Task Measures of Effectiveness and Performance:

- Improve QOL for remote and austere installations (6.1.)
- Promote quality MWR programs and predictable Army Community Service (ACS) Programs and Services (6.2.)
- Develop applications that enhance the Army community (6.3.)
- Communicate the Army’s efforts to improve QOL (6.4.)
- Spiritual revitalization of Army culture to improve QOL (6.5.)

Milestones:

Milestone 1: Improve marketing of FMWR Programs at the Big 4 (Fort Polk, Fort Irwin, Fort Hood, and Alaska).

Start Date: FY20Q1; **End Date:** FY22Q4

Milestone 2: Define precise authorities for installations designated by the DoD as “remote and isolated.”

Start Date: FY20Q1; **End Date:** FY23Q4

Milestone 3: Establish Army Community Service Delivery Model & Strategy

Start Date: FY20Q1; **End Date:** FY23Q1

Milestone 4: Develop applications that enhance the Army community (e.g. E-EFMP, Digital Garrison Application).

Start Date: FY20Q1; **End Date:** FY24Q4

Milestone 5: Evaluate Military & Family Life Counselors by garrison

Army People Strategy: Military Implementation Plan 2.0

Start Date: FY20Q1; **End Date:** FY23Q2

Milestone 6: Spiritual Readiness Initiative as a joint effort with OTSG/OCCH

Start Date: FY20Q1; **End Date:** FY23Q1

Task 2.2.g: Economic Security and Financial Readiness

OPR: ASA(M&RA)-QOL; **OCR:** DCS G-9

The economic security and financial readiness of Soldiers and Army Families is fundamental to readiness. Poor economic security and financial problems are linked in scientific literature to domestic abuse/violence and suicide. Financial burdens place Soldiers at risk during deployments as concerns for their families may distract them from their missions. Finally, poor eating, lack of sleep due to financial stress, and substandard living conditions (sometimes due to high rental prices) affect the health and well-being of Soldiers and impact their operational readiness.

Task End State: By December 2023, Soldiers and Army Families will have experienced multiple tools and helping agencies to improve their economic security and overall well-being.

Dependencies: None Identified.

Task Measures of Effectiveness and Performance:

- To be determined by Year of Economic Security Advisory Panel

Milestones:

Milestone 1: Obtain SECARMY approval to plan and launch Year of Economic Security

Start Date: FY22Q3; **End Date:** FY22Q3

Milestone 2: Finalize monthly themes, activities, and talking points with partners

Start Date: FY22Q3; **End Date:** FY22Q4

Milestone 3: Receive and review action plans from Installation Management Command (IMCOM) and installations

Start Date: FY23Q1; **End Date:** FY23Q1

Milestone 4: Launch the Year of Economic Security

Start Date: FY23Q2; **End Date:** FY23Q2

Task 2.2.h: Exceptional Family Member Program (EFMP) Redesign

OPR: ASA(M&RA)-QOL; **OCR:** DCS G-9

Approximately 46K Soldiers have ~55K family members enrolled in EFMP. Throughout the years, Army Families have expressed growing frustration with the lack of transparency and trust in the identification/enrollment, assignment, and family support

Army People Strategy: Military Implementation Plan 2.0

processes and programs for Exceptional Family Members (EFM). The Army is transforming EFMP to include the establishment of a single office to integrate the work of all partners and the development of the Enterprise (E-EFMP system)—an enterprise case management system connecting all stakeholders and providing Army Families with transparency into the EFMP processes. Congressional interest remains high in the development of standardized EFMP practices across the Services with many recent National Defense Authorization Act (NDAA) requirements to ensure compliance.

Task End State: Improved experience for Army Families enrolled in the EFMP, resulting in greater trust in the program and greater satisfaction with enrollment, assignment, and family support processes.

Dependencies: None Identified.

Task Measures of Effectiveness and Performance:

- Improved customer satisfaction
- Reduced timelines for identification/enrollment and assignment coordination
- Reduction of problematic assignments

Milestones:

Milestone 1: Launched first phase of E-EFMP system

Start Date: FY22Q2; **End Date:** FY22Q2

Milestone 2: Launch final phase of the E-EFMP system across the Army

Start Date: FY22Q4; **End Date:** FY22Q4

Milestone 3: Incorporate Reserve Component (Guard and Reserve) requirements into E-EFMP system

Start Date: FY22Q4; **End Date:** FY23Q4

Milestone 4: Assess the E-EFMP system and make modifications as necessary

Start Date: FY23Q1; **End Date:** FY23Q4

Milestone 5: Stand up EFMP central office

Start Date: FY23Q2; **End Date:** FY23Q2

Milestone 6: Identify relevant data and develop process for collecting and analyzing data to improve processes to meet desired goals in support of Improved customer satisfaction; reduced timelines for identification, enrollment, and assignment coordination; and reduction of problematic assignments.

Start Date: FY23Q1; **End Date:** FY23Q2

Army People Strategy: Military Implementation Plan 2.0

Objective 2.3: Expanded care options via AAFES for remote and isolated areas.

Task 2.3.a: Expanded care options via AAFES for remote and isolated areas

OPR: ASA(M&RA)-QOL; **OCR:** DCS G-9

The Army and Air Force Exchange Service (AAFES) coordinates with Army Materiel Command and the Army Surgeon General to establish medical services to support the military community, including at remote and isolated locations. Approved healthcare services are authorized to serve Active-Duty dependents, Retired Soldiers, dependents of Retired Soldiers, disabled veterans, and DoD Common Access Cardholders. AAFES does not compete with installation Medical Treatment Facilities (MTF), but seeks to provide services that eligible beneficiaries may pursue outside of the MTF. Several memorandums of understanding have already been signed to support these efforts: FY11 Memorandum of Understanding (MOU) to provide Optometry Services on Army Installations (15 Nov 2011); FY20 MOU to provide Dental Services on Army Installations (24 Dec. 2015); FY21 MOU to provide Chiropractic Services on Army Installations (10 Feb. 10, 2021).

Dependencies: None Identified.

Task Measures of Effectiveness and Performance:

- Number of Optometry Clinics on Army Installations
- Number of Dental Clinics on Army Installations
- Number of Chiropractic Clinics on Army Installations

Milestones:

Milestone 1: ASA(M&RA)-QOL, AAFES, Office of the Surgeon General (OTSG), and Defense Health Agency (DHA) to come to agreement on provision of behavioral health-care services on Army remote and isolated installations.

Start Date: FY23Q1; **End Date:** FY23Q4



Chapter 3: Acquire Talent
Military Implementation Plan 2.0

Army People Strategy: Military Implementation Plan 2.0

Acquire Talent

Lead integrator: TRADOC

Introduction: By 2030, the Army will market, recruit, and onboard the diverse talent needed for the multi-domain force envisioned in the *Army Strategy*. To do this we must understand the marketplace, which is shaped by generational effects, factors and events both within and outside Army control, and other shocks that affect an individual's attitude toward Army service. It also requires an appreciation for individual decision-making behavior – the role of information framing, the impact of vivid images of military service, and overcoming the confirmation bias engendered by unfavorable representations of the Army by America's pop culture and media with incomplete context.

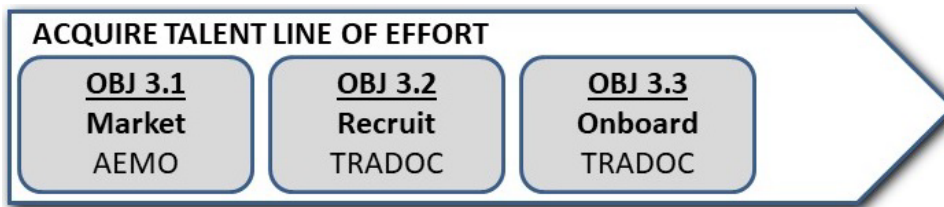

Figure 3: Acquire Talent APS Line of Effort

We must modernize accessions efforts to gain competitiveness in attracting and keeping talent. In recognition of this war for talent, the 2018 *Army Strategy* directed the Army to perform an end-to-end review of the accession process. The *Army People Strategy* reinforced this direction by naming accessions reform as one of six near term priorities. The APS also identified the Acquire Talent LOE as the Army's main effort through 2030.

Figure 4: Acquire Talent LOE Strategic Outcomes

The Army will implement the Acquire Talent Line of Effort by achieving these six strategic outcomes:

1. The Army produces an enduring increase in high quality leads
2. The Army achieves an expanded propensed and eligible labor supply
3. The Army has increased recruiter productivity
4. The Army has reduced Army Attrition across the force
5. The Army has enabled / improved people data / analytics
6. The Army has optimized resources (labor, capital, technology, and funding)

Army People Strategy: Military Implementation Plan 2.0

Objective 3.1: Market the Army

OPR: Army Enterprise Marketing Office (AEMO); **OCR:** DCS G-1, TRADOC

Within the context of the APS, the objective of Marketing is to: *Employ innovative new techniques to increase awareness of the breadth of Army service opportunities and to shape preferences, targeting efforts against specific and diverse talent pools in the American labor market where critical talent is most likely to reside.*

More specifically, we must shape perceptions of the Army and Army service; increase awareness and knowledge about each of the components, opportunities in the officer, warrant officer, and enlisted ranks, as well as the breadth of job and educational opportunities; generate leads for recruiters to action; and compete successfully for top talent against all other entry-level labor employers. Marketing is aligned with the sixth objective in the SECARMY's February 2022 Message to the Force.

(APS Near-Term Priority #2) - The Army Enterprise Marketing Office will transform all marketing communications, technologies, and operations, ensuring we attract the diverse military and civilian talent needed to maintain the All-Volunteer Force.

The Chief of Army Enterprise Marketing has the responsibility to lead the Army's marketing efforts to develop, optimize, and implement campaigns that will drive lead generation. Achieving this will require multi-channel and integrated approaches across physical and digital platforms that vary by demographic, psychographic, and geographic region. Such actions, demanded by a competitive employment market, will drive efforts in reaching and inspiring the diverse and talented volunteers that will lead the Army of 2030 and beyond.

Objective End State: The end state for the Acquire Talent LOE is fully manned formations of ready, diverse, professional, and integrated Soldiers of unmatched lethality. Three supporting objective areas that make up the Acquire Line of Effort are Market the Army, Recruit the Army, and Onboard the Army.

Objective Measures of Effectiveness and Performance:

- Percentage of youth propensed to serve in the Army (goal: **increase**) (Source: *Joint Advertising Market Research and Studies (JAMRS) Youth Poll, as provided by AEMO*)
- Percentage of youth who never previously considered service in the military (goal: **decrease**) (Source: *JAMRS Youth Poll, as provided by AEMO*)
- Number of Marketing Qualified Leads generated (Source: *AEMO*)
- Conversion Rate from Marketing Qualified Leads to Contracts (goal: **increase**) (Source: *AEMO*)
- Conversion rate of Reserve Officers' Training Corps (ROTC) Sub-Site Visits to Marketing Qualified Leads (goal: **increase**) (Source: *AEMO*)

Army People Strategy: Military Implementation Plan 2.0

Key Tasks:

Task 3.1.a: Continue the Building Out and Resourcing of AEMO and FA58

OPR: AEMO; **Data Owner:** AEMO

Currently at 60% its required end strength, FA58 will continue to scale in personnel and capability while continuing to deliver marketing excellence across the accessions enterprise.

Task End State: FA58 personnel continue developing the talent, skills, and abilities necessary to effectively manage and provide the subject-matter expertise that will inform the Army's marketing activities. Additionally, FA58's growth will enable AEMO to better facilitate marketing initiatives, at the national, regional, and local levels across the accessions enterprise.

Dependencies: None Identified.

Task Measures of Effectiveness and Performance:

- FA58 is at 90% of its current number of authorized billets pending ongoing Army Structure (ARSTRUC) processes.
- Approximately 25 officers are recruited into FA58
- Professional Development and Executive Education (PD/Exe. Ed.) programs are appropriately resourced for FA58 development and 100% of FA58s receive PD/Exe. Ed. opportunities.

Milestones:

Milestone 1: Complete for resourcing of FA58 and all marketing activities for AEMO through Army Marketing Plan (AMP) approval.

Start Date: FY23Q1; **End Date:** FY25Q4

Milestone 2: Recruit approximately 25 FA58 officers to maintain operational capacity at AEMO and across the accessions enterprise.

Start Date: FY23Q1; **End Date:** FY233Q4

Milestone 3: Leverage PD/Exe. Ed. programs to build talent base and ensure high quality, knowledgeable officers continue to lead the marketing enterprise.

Start Date: FY23Q1; **End Date:** FY25Q4

Task 3.1.b: Successfully Integrate Marketing Infrastructure Across the Accessions Enterprise

OPR: AEMO; **Data Owner:** AEMO

Army marketing requires the ability to provide regionally relevant marketing content, grounded in data-driven research and analytics, to facilitate the accession mission. The establishment of Regional Marketing Offices (RMOs) and incorporation of FA58

Army People Strategy: Military Implementation Plan 2.0

personnel across accession organizations will help synchronize marketing activities and efforts between the national and local level.

Task End State: AEMO can effectively provide regionally relevant marketing content, advisement and planning capability to the accessions enterprise. Additionally, AEMO can better coordinate and synchronize marketing activities and efforts based on the geographic, demographic, and psychographic distinctiveness of that region with measurable results.

Dependencies: None Identified.

Task Measures of Effectiveness and Performance:

- Five RMOs established at IOC
- 100% of RMOs incorporated into annual marketing plan development for regions
- All accession HQs [TRADOC, United States Army Cadet Command (USACC), United States Army Recruiting Command (USAREC)] have at least one FA58 billet manned

Milestones:

Milestone 1: Establish Five Regional Marketing Offices (RMOs)

Start date: FY23Q1; **End date:** FY24Q4

Milestone 2: Integrate work processes focused across product lines [office, enlisted, etc.]

Start date: FY23Q1; **End date:** FY23Q4

Milestone 3: Begin incorporating FA58s into Stakeholder HQs

Start date: FY23Q1; **End date:** FY24Q4

Task 3.1.c: Develop Marketing Campaigns to Generate Quality Leads

OPR: AEMO; **Data Owner:** AEMO

Army marketing will continue to create and distribute relevant, compelling, and curated content and campaigns as a mechanism for generating leads. Driven by data on the prospect audience, along product lines, and by in-market performance, these campaigns will represent multi-channel and integrated experiences that leverage insights on consumer behavior and decision-making to maximize desired marketing objectives.

Task End State: Campaigns executed to drive target market propensity, generate leads, and increase employment contracts. Campaigns are critical to supporting the accessions mission and are tailorable to address shifting marketing conditions and public sentiment.

Task Measures of Effectiveness and Performance:

Army People Strategy: Military Implementation Plan 2.0

- Increase of marketing lead conversions to employment contracts following campaign execution.

Dependencies: None Identified.

Milestones:

Milestone 1: Prioritize based on AR 601-208

Start date: FY23Q1; **End date:** FY25Q4

Milestone 2: Publish specifics in the AMP

Start date: FY23Q1; **End date:** FY25Q4

Task 3.1.d: Revitalize the Army Brand

OPR: AEMO; **Data Owner:** AEMO

Modernizing the Army Brand remains a necessary component in establishing and maintaining relevancy within the prospect market. A natural occurrence with precedence and brand management implications, reevaluating and restructuring how the public perceives and interacts with the Army brand facilitates on-going efforts to make the Army a favored employer for talented prospects, their influencers, and community stakeholders.

Task End State: Metrics regarding employment and competitiveness are improved. Army Brand initiatives help reestablish relatability and trust with the Army as both a service and source of competitive employment.

Dependencies: None Identified.

Task Measures of Effectiveness and Performance:

- Improvement in performance-based metrics generated regarding the Army brand [aggregated sentiment trends, employment value proposition awareness, prospect propensity surveys, psychographic mapping, etc.]
- Perceptual deliver gap for key attitudinal and self-efficacy benefits improves by +15% in 2 years from launch (improves key Purpose and Passion/Community and Connection (P2C2) metrics among non-Rejector youth.

Milestones:

Milestone 1: Improve the Army Brand to Increase Awareness of the Army Value Proposition.

Start date: FY23Q1; **End date:** FY24Q4

Milestone 2: Implement/Launch the Brand Platform.

Start date: FY23Q4; **End date:** FY25Q4

Army People Strategy: Military Implementation Plan 2.0

Milestone 3: Use appropriate data to track and evaluate brand sentiment and propensity trends.

Start date: FY23Q1; **End date:** FY25Q4

Task 3.1.e: Integrate Data Use into Marketing the Army Effectively

OPR: AEMO; **Data Owner:** AEMO

Army marketing decisions are informed by data and require a system to ensure adequate data collection and the analytical capabilities to continue to monitor changes in consumption patterns, sentiment, and campaign effectiveness. As an enterprise, Army marketing efforts requires synchronizing systems across all accession stakeholders to achieve insights and effectively optimize on-going activities.

Task End State: Interoperability of marketing and prospect/personnel tracking across HR and accessions systems established

Dependencies: Task 3.2.b: Develop and field Army Accessions Information Environment (AIE)

Task Measures of Effectiveness and Performance:

- Migration of Enterprise Marketing Management (EMM) and associated marketing and accessions systems to a cloud computing environment complete and usable

Milestones:

Milestone 1: Complete the migrations of EMM and associated systems to a cloud computing environment that will assist AEMO in leveraging data-driven insights to drive strategic marketing decisions.

Start date: FY23Q1; **End date:** FY24Q4

Milestone 2: Establish interoperability with AIE

Start date: FY25Q1; **End date:** FY25Q4

Task 3.1.f: Develop and launch the Junior Reserve Officer Training Corps (JROTC) Cyber/STEM Elective Course

OPR: USACC

The Army JROTC Cyber Program Pilot is a four-year high school specialized JROTC program focused on student development of technical skills. JROTC Cyber is planned to expand to approximately 80 schools by 2030. JROTC Cyber requires instructors who have technical training and experience.

Traditional JROTC reaches students in approximately 1700 schools. Development of a JROTC Cyber/STEM Elective course enables JROTC cyber to scale to thousands of students enrolled in traditional JROTC, introducing them to civilian and military careers in high demand Army priority areas. Course design enables the course to be taught by existing JROTC instructors within elective hours allowed in the traditional program. The

Army People Strategy: Military Implementation Plan 2.0

elective nature of the course design allows program updates to meet changing Army modernization priority areas where talent needs exist.

Task End State: All JROTC programs have access to JROTC Cyber/STEM curriculum, increasing the number of students who have developed an interest in STEM studies and careers after high school. The curriculum map and curriculum plan provide guidance for course development.

Task 3.1.f1: Develop curriculum

In collaboration with USACC, develop curriculum map and curriculum development plan for JROTC Cyber/STEM Elective Course to be implemented within the traditional JROTC program.

Provide additional opportunities for JROTC cadets to grow knowledge of and propensity to engage in STEM careers.

Task End State: Curriculum map and curriculum development plan created

Dependencies: None Identified.

Task Measures of Effectiveness and Performance:

- Curriculum map and curriculum development plan created.

Milestones:

Milestone 1: Curriculum map and curriculum development plan created

Start date: FY23Q1; **End date:** FY25Q4

Task 3.1.g: Develop and launch the JROTC Cyber Pilot

OPR: ASA(M&RA); **Data Collection:** USACC

The Army JROTC Cyber Program Pilot simultaneously addresses critical cybersecurity talent challenges for the Army and the nation. The pilot will offer a new advanced placement level computer systems and cyber security curriculum created by national experts. It will contribute and expand a cadre of highly qualified secondary educators for the nation. The JROTC Pilot program will graduate students prepared for employment and continued education in this critically important sector of national security. By partnering with Army Cyber Command, USACC, TRADOC, academia, national defense agencies and industry leaders, the JROTC Cyber Program Pilot will modernize and complement the traditional JROTC program with innovative curriculum designed to prepare a new generation of cyber professionals entering the civilian workforce, military or post-secondary education.

The Army will locate JROTC Cyber Pilot Program Centers of Excellence in geographic areas that can provide co-curricular and extracurricular opportunities for students and instructors. The Army will give priority to geographic areas that have a strong cybersecurity and computer science research emphasis as exhibited by local

Army People Strategy: Military Implementation Plan 2.0

business/industry, military installations and higher education partners. Sites will also depend on support from schools/districts and state and local leadership for implementing advanced studies in computer science and cyber education. Community leadership that fosters innovative learning experiences through professional mentors is essential for student success.

Dependencies: Program expansion is dependent upon funding. Curriculum updates require execution of program evaluation/review of JROTC Cyber pilot schools and review of alignment to curriculum map and nationally recognized competencies, standards, and objectives.

Task 3.1.g1: Update JROTC Cyber program curriculum, course content, and program objectives

OPR: ASA(M&RA); **Data Owner:** USACC

Provide program updates based on program evaluation/review and cyber content requirements to align with nationally recognized competencies, standards, and objectives.

Task End State: JROTC Cyber course content is updated and aligned to curriculum map and nationally recognized competencies, standards, and objectives.

Task Measures of Effectiveness and Performance

- None Identified. Defaults to Milestone completion status.

Milestones:

Milestone 1: JROTC Cyber Courses 1 and 2 Updated, including updates to instructor training and related component updates.

Start date: FY23Q1; **End date:** FY23Q4

Milestone 2: JROTC Cyber Courses 1-3 Updated, including updates to instructor training and related components

Start date: FY24Q1; **End date:** FY24Q4

Milestone 3: JROTC Courses 1-4 Updated, including updates to instructor training and related components.

Start date: FY25Q1; **End date:** FY25Q4

Task 3.1.g2: Expand JROTC Cyber annually to meet program goals

OPR: ASA(M&RA); **Data Owner:** USACC

JROTC Cyber program grows to approximately ten sites per year to reach the program goal of 80 sites by 2030.

Army People Strategy: Military Implementation Plan 2.0

Task End State: JROTC Cyber grows a talent pipeline of graduates ready to enter the field of cybersecurity.

Task Measures of Effectiveness and Performance

- None Identified. Defaults to Milestone completion status.

Milestones:

Milestone 1: In collaboration with USACC, onboard ten program sites.

Start date: FY23Q1; **End date:** FY23Q4

Milestone 2: In collaboration with USACC, onboard ten program sites.

Start date: FY24Q1; **End date:** FY24Q4

Milestone 3: In collaboration with USACC, onboard ten program sites.

Start date: FY25Q1; **End date:** FY25Q4

Task 3.1.h: Expand Science, Technology, Engineering and Mathematics (STEM) Programming through Strategic Stakeholder Engagement (SSE)

OPR: ASA(M&RA); **Data Owner:** ASA(M&RA)

ASA(M&RA) seeks to grow the number of youths engaged in STEM courses and activities to increase their awareness of and propensity to engage in careers that align with Army workforce needs. The foundation of this effort includes developing strategic partnerships with K-12, academia, business, industry, and key Army stakeholders to provide unique opportunities to enhance student interest and aptitude in targeted expansion areas that complement Army programs. These stakeholder networks are critical to the expansion of JROTC programs and the inclusion of STEM electives in areas such as cybersecurity.

Strategic Stakeholder Engagement (SSE) includes networking with state and local leaders, K12 leaders and other critical enablers at national and state venues/events. Partnerships will focus on key areas that impact the future Army civilian and military workforce: Increase civilian knowledge of the value and benefit of engaging with the Army through programs such as JROTC, ROTC, AEOP, and other focus programs and expand the ability of the Army to broaden access to K12 educators.

The Expansion of STEM Programming task reinforces the SSE effort by increasing student access to STEM programs and opportunities. The task includes the development of STEM and career exploration programs to increase the availability of young adults seeking preparation in areas such as cyber, math, computer science, artificial intelligence, technology, and wellness. Programs will include career exploration and decision-making skills related to careers and ability to obtain and retain necessary clearances for certain fields.

Army People Strategy: Military Implementation Plan 2.0

Expansion of STEM Programming and Strategic Partnerships enables the Army expand student knowledge of career opportunities in STEM fields and Army focus areas.

SSE provides engagement with K12 leaders and critical enablers to increase student awareness of and propensity to engage in careers that align with DA civilian and workforce needs. Middle school STEM and career outreach programs increase student interest in taking JROTC and JROTC Cyber, STEM courses, and activities in high school and engages students in decision making skills related to future careers and ability to obtain a security clearance.

Task End State: Increased number of high school graduates pursuing military careers in Army priority areas.

Dependencies: Dependent upon funding for middle school outreach activities. Updates to the School District Strategy require the execution of the program evaluation/review of pilot schools.

Task Measures of Effectiveness and Performance

Measures of Performance:

- Number of partners and/or partner engagements from academia, industry and other stakeholders supporting JROTC Cyber and STEM efforts.
- Implementation of the K12 Engagement plan.
- Implementation of JROTC Cyber and components of the School District Strategy (SDS).
- Number of youths participating in JROTC Cyber and related programs.
- Measures of Effectiveness:
 - Among program participants, number of students engaged in STEM activities/programs.
 - Among program participants, increased student knowledge of STEM careers.
 - Among program participants, increased positive views regarding STEM and Army careers.
- Implementation of JROTC Cyber programs.

Milestones:

Milestone 1: Implement K12 Engagement plan and implement middle school outreach activities to increase student interest in STEM programs such as cybersecurity, computer science or other related programs.

Start date: FY24Q1; **End date:** FY28Q4

Milestone 2: Update K12 Engagement Plan strategic plan.

Start date: FY24Q1; **End date:** FY24Q4

Army People Strategy: Military Implementation Plan 2.0

Milestone 3: Update and implement SDS (School District Strategy) to support JROTC Cyber program based on program evaluation/review and implementation of JROTC Cyber Courses 1-4.

Start date: FY26Q1; **End date:** FY26Q4

Task 3.1.i: Expand JROTC in undersubscribed states

OPR: USACC

To achieve a fair and equitable distribution of JROTC units throughout the nation or within underrepresented states to have equitable access to JROTC.

Task End State: Distribution of JROTC into targeted states reaches the "fair and equitable" subscriber rate as defined by the formula ((Number of high schools in the state/Total high schools in the nation) * Funded Ceiling) measured annually through FY 25.

Dependencies: None Identified.

Task Measures of Effectiveness and Performance:

- Army manpower authorizations provided to support opening and sustainment of new JROTC programs in accordance with FY opening targets
- OMA funds provided to support opening and sustainment of new JROTC programs in accordance with FY opening targets
- FY opening targets achieved
- JROTC Instructors hired to support expansion by FY
- Enrollment targets for JROTC classes met

Milestones:

Milestone 1: USACC open 50 programs in undersubscribed locations.

Start date: FY23Q1; **End date:** FY23Q4

Milestone 2: Implement the outreach and communications strategy.

Start date: FY23Q1; **End date:** FY23Q4

Milestone 3: Recruit instructors to meet expansion requirements.

Start date: FY23Q1; **End date:** FY23Q4

Milestone 4: USACC open an additional 50 programs in undersubscribed locations.

Start date: FY24Q1; **End date:** FY24Q4

Milestone 5: Appropriately resource the sustainment of the previous 81 programs.

Start date: FY24Q1; **End date:** FY24Q4

Milestone 6: Recruit instructors to meet expansion requirements.

Army People Strategy: Military Implementation Plan 2.0

Start date: FY24Q1; **End date:** FY24Q4

Milestone 7: USACC open 50 programs in undersubscribed locations.

Start date: FY25Q1; **End date:** FY25Q4

Milestone 8: Appropriately resource the sustainment of the previous 131 programs.

Start date: FY25Q1; **End date:** FY25Q4

Milestone 9: Recruit instructors to meet expansion requirements.

Start date: FY25Q1; **End date:** FY25Q4

Task 3.1.j: Expand Marketing for the Army National Guard

OPR: Army National Guard (ARNG); **OCR:** AEMO

Inspire today's generation to find their purpose for tomorrow. Build trusting teams across the Total Army to elevate the Army and Army National Guard brand, and position the 54 States, Territories, and District of Columbia to reach today's generation and their centers of influence with a path to service.

Dependencies: None Identified.

Task Measures of Effectiveness and Performance:

- Count of leads generated for the total ARNG by end of FY23.
- Increase percentage of Centers of Influence that support and recommend ARNG service.
- Reduce cost per lead by 5%
- Improving lead conversion rate by 10%

Milestones:

Milestone 1: Employ local media strategies to assist in recruiting within a 50-mile radius of unit vacancies

Start date: FY23Q1; **End date:** FY25Q4

Milestone 2: Create clear messaging that speaks directly to the interests and values of Generation Z (1997 and later).

Start date: FY23Q1; **End date:** FY25Q4

Milestone 3: Empower the 54 States, Territories, and District of Columbia to deploy media and marketing assets in a timely and targeted manner.

Start date: FY23Q1; **End date:** FY25Q4

Milestone 4: Provide greater flexibility to create state-specific creative that nests with the larger ARNG brand.

Start date: FY23Q1; **End date:** FY25Q4

Army People Strategy: Military Implementation Plan 2.0

Milestone 5: Inspire centers of influence to support and recommend ARNG service

Start date: FY23Q1; **End date:** FY25Q4

Milestone 6: Drive prospects to consider ARNG service.

Start date: FY23Q1; **End date:** FY25Q4

Objective 3.2: Recruit the Army

OPR: TRADOC; **OCR:** DCS G-1

Within the context of the APS, the objective of Recruiting is to: *Screen and select potential Soldiers who actively respond to Army marketing efforts and seek service with the Army.*

The Army will transform its recruiting practices, infrastructure, and processes to attract high-quality talent through a competitive value proposition, using relevant market intelligence, big-data and artificial intelligence (AI) informed talent prospecting, and state-of-the-art tools. In so doing, the Army will adjust its marketing and recruiting strategies to prompt the nation's youth to seek the recruiter, rather than the opposite.

The Army will expedite the development and fielding of tools, which will assess the cognitive and non-cognitive talents of potential applicants, to provide the best fit for both the prospective Soldier and the Army. We will develop a program for applicants which will utilize compensatory screening and individually targeted incentives to provide potential recruits a contract that best satisfies their individual preferences while providing the ability to offer attractive incentive packages which consider the individual's qualifications and give the Army the highest return on investment.

We will further develop and implement non-cognitive screening tools to help screen recruit prospects with marginal Armed Forces Qualification Test (AFQT) scores to enable a "whole person" approach to predict their performance. The Army will develop and implement non-cognitive screening tools which support the whole-person accession concept to improve lethality, readiness, and resilience in Army personnel.

The Army will emphasize the Soldier for Life (SFL) Program as part of Army Culture, highlighting the fact that the SFL Program has been recognized as among the best in the Department of Defense. Where possible, invite recently transitioned Soldiers to share their positive SFL experiences with potential recruits in person and through social media.

Most importantly, we must achieve the Army's recruiting mission as a critical component driving end strength. Various Army efforts are launching or continuing in this space in support of the SECARMY's February 2022 Message to the Force, as well as striving to meet mission requirements in one of the most challenging recruiting environments in years. Overall mission attainment is critical, but it is also important to ensure recruiting efforts are inclusive; bring in high quality, talented young people; and sub-missions to fill critical Military Occupational Specialties (MOSs) and positions are also successful. The

Army People Strategy: Military Implementation Plan 2.0

Recruit objective is directly tied to the APS Near Term Priority #3 and is further aligned with the sixth objective in the SECARMY's February 2022 Message to the Force.

(APS - Near Term Priority #3) Reform accession activities based on an end-to-end evaluation of Total Army accession and retention programs. Develop and implement programs, policies, and systems to attract and align new military and civilian talent with best-fit jobs across the Army, and improve IET graduation rates. Lastly, conduct AIE design, prototyping, and phased releases.

Objective Measures of Effectiveness and Performance:

- Percentage of Recruiting mission accomplished (goal: **100%**) (Source: Directorate of Military Personnel Management (DCS G-1 DMPM))
- Percentage of Enlisted Recruiting mission accomplished (goal: **100%**) (Source: DCS G-1 DMPM)

Key Tasks:

Task 3.2.a: Expand Specialized Recruiting Initiatives for the Army National Guard

OPR: ARNG; **OCR:** USAREC

Army National Guard accomplishes their accessions mission delivering a diverse military force that represents the people it serves.

Dependencies: Task 3.1.j: Expand Marketing for the Army National Guard, Contracting, access to research participants

Task Measures of Effectiveness and Performance:

- Capture number of calls, leads, area canvasses performed in the past and determine the number of initial candidates identified and processed (Recruitment velocity)
- Classify unit vacancy fill rate for prioritized area versus non-prioritized area
- Capture cost associated with each level of production efforts last year
- Cost per fill
- Determine delta for past Recruiting and Retention Non-Commissioned Officer (RRNCO) missions over 5 years
- Determine in accordance with market share data from all service components to determine percentage meeting target annual RRNCO missions in prioritized versus non-prioritized areas
- Document the virtual recruiting operation from lead generation and process times (measure time it takes from identification to actual placement) - determine ways to reengineer process - determine bottlenecks and/or redundant areas or areas experiencing unexpected delays to determine how to correct or improve process
- measure ROI - for prioritized areas versus non-prioritized areas
- Determine areas where most talent is harvested through T10/32 exchange cooperatives and determine what factors provide high talent presence (population density, schools, etc.)

Army People Strategy: Military Implementation Plan 2.0

Milestones:

Milestone 1: Prioritize ratio of RRNCOs to ESO mission in accordance with National Guard Regulation (NGR) 601-1

Start date: FY23Q1; **End date:** FY25Q4

Milestone 2: Scale Marine to Guard and SF programs to support AC2RC programs

Start date: FY23Q1; **End date:** FY25Q4

Milestone 3: Strategic placement of Store Front Recruiting Offices

Start date: FY23Q1; **End date:** FY25Q4

Milestone 4: Assign RRNCO missions to align with Market Share analysis by zip code

Start date: FY23Q1; **End date:** FY25Q4

Milestone 5: Incentivize production to meet Operational Environment (OE) requirements

Start date: FY23Q1; **End date:** FY25Q4

Milestone 6: Leverage Virtual Recruiting opportunities to reach niche markets

Start date: FY23Q1; **End date:** FY25Q4

Milestone 7: Title 10/Title 32 professional development tours

Start date: FY23Q1; **End date:** FY25Q4

Milestone 8: Prioritize funding streams in accordance with 1-N lists

Start date: FY23Q1; **End date:** FY25Q4

Task 3.2.b: Develop and field Army Accessions Information Environment (AIE)

OPR: TRADOC G-3/5/7

The core business problem facing the Accessions Enterprise is the workforce cannot, in real-time, create, access, apply, transport, and authoritatively register information for enterprise-wide use, nor map and transfer required validated data to the appropriate authoritative database. Today each command within the Accessions Enterprise relies on a combination of command unique systems and manual processes to accomplish missions. As a result, the Army Accessions Enterprise is unable to operate effectively because they use 11 systems and 33 modules to attempt to accomplish their mission. Having one system would accomplish the mission more effectively and efficiently. AIE is a program of record established to confront the challenges facing the Accessions Enterprise. It supports Army strength through its four (4) missions: (1) Enlist Soldiers, (2) Commission Officers, (3) Fulfill In-Service Requirements, and (4) Support and Sustain. The AIE leverages the similarity of missions across all Accessions Enterprise commands to provide a net capability supporting the eight (8) Accessions Enterprise

Army People Strategy: Military Implementation Plan 2.0

core capabilities, using common architectures and standards to provide a fully integrated enterprise level capability enabling transparency, efficiency, and effectiveness of the accessions workforce to acquire the best-qualified talent to meet all Army manning requirements.

AIE is built on a foundation of data, information technology architectures and standards, infrastructure, and analytical tools to achieve a modern end-state using configurable, Commercial Off the Shelf (COTS) based software. The AIE solution is being configured as a net-centric enterprise solution characterized by standardized architecture; maximized authoritative data discovery and sharing; fully integrated capabilities; intuitive ability to access, visualize, assess, and understand data; integrated and automated business processes; and single source data entry.

Dependencies: None Identified.

Task 3.2.b1: In collaboration with USAREC, ARNG, USACC, and CIMT, develop and field the Army Accessions Information Environment

OPR: TRADOC G-3/5/7; **OCR:** AEMO

Develop and field AIE across the accessions enterprise by coordinating and facilitating development and testing of each AIE release; Deploying each AIE release to the designated units coordinating with the commands; Coordinating the sunset of legacy systems with Commands and Human Resources Command (HRC).

Task End State: AIE fully deployed across the entire accessions enterprise.

Dependencies: None Identified.

Task Measures of Effectiveness and Performance:

- Program reviews and updates will be documented and provided to the Army, Program Executive Office for Enterprise Information Systems (PEO-EIS) and TRADOC leadership on a periodic basis.

Milestones:

Milestone 1: Wave 1 Release 1b Operational Pilot developed and fielded to the designated units beginning FY23Q3.

Start date: FY23Q3; **End date:** FY24Q4

Milestone 2: Conduct Decomposition for Wave 2 requirements for In-Service recruiting missions, direct commission missions and enlisted recruiting capabilities of marketing, intel, training, and pay functions FY24Q1.

Start date: FY24Q1; **End date:** FY24Q3

Milestone 3: Begin development of Wave 2 Release 1 in FY24Q3.

Start date: FY24Q4; **End date:** FY25Q3

Army People Strategy: Military Implementation Plan 2.0

Milestone 4: Begin development of Wave 2 Release 2 in FY25Q2.

Start date: FY25Q2; **End date:** FY25Q4

Milestone 5: Begin development of Wave 2 Release 2 in FY25Q3.

Start date: FY25Q3; **End date:** FY26Q1

Milestone 6: Conduct requirements analysis and decomposition for ROTC mission sets and functions FY25Q3.

Start date: FY25Q3; **End date:** FY26Q1

Task 3.2.c: Longitudinal Validation for Option 20 Soldiers

OPR: Army Research Institute (ARI); **OCR:** Army Resiliency Directorate (ARD) in support of the Vice Chief of Staff of the Army (VCSA); **Data Owner:** ARI

Previous findings have demonstrated that assignment to Alaska creates unique quality of life challenges for Soldiers and may contribute to higher than average suicide rates. ARI, in coordination with ARD, has been tasked to conduct a longitudinal study to determine how Soldiers who volunteer for assignment to Alaska differ from those who are assigned.

Dependencies: Contracting, access to research participants

Task Measures of Effectiveness and Performance:

- None Identified. Defaults to Milestone completion status.

Milestones:

Milestone 1: Develop the Option 20 Soldier assessment

Start date: FY23Q2; **End date:** FY23Q4

Milestone 2: Collect and analyze Option 20 Soldier data and provide recommendations

Start date: FY24Q1; **End date:** FY24Q3

Task 3.2.d: Implement Assessment of Recruit Motivation and Strength Program 2.0 (ARMS 2.0)

OPR: USAREC; **OCR:** ARI, TRADOC

An increasing number of America's youth are not meeting Army enlistment standards for weight and body fat; however, some can exceed quality standards in other important areas. The Army's Assessment of Recruit Motivation and Strength (ARMS) 2.0 Pilot Program is a performance-based tool to assess Army applicants who are disqualified for exceeding accession body fat composition standards. This Pilot allows an applicant to enlist if they show they are extremely fit, by passing the Occupational Physical Assessment Test. Participants must meet Army body fat composition retention standards no later than one year after entering service. ARI and TRADOC will provide

Army People Strategy: Military Implementation Plan 2.0

the final results from the longitudinal study to Army senior leaders no later than six months after the conclusion of the pilot program.

Task End State: This pilot will inform direction on permanent policy regarding recruiting and accession.

Dependencies: None Identified.

Task Measures of Effectiveness and Performance:

- Percentage of Soldiers who enlisted under ARMS 2.0 Pilot successfully complete their terms of service compared to percentage of those who met height and weight standards and successfully complete their terms of service.

Milestones:

Milestone 1: ARI briefs Army senior leaders on longitudinal study results and makes recommendation.

Start date: FY23Q1; **End date:** FY23Q4

Milestone 2: Army Senior Leaders decide on the programs.

Start date: FY24Q1; **End date:** FY24Q4

Task 3.2.e: Evaluate Tailored Adaptive Personality Assessment System (TAPAS) for Service Compatibility

OPR: ARI

The Secretary of Defense accepted the recommendations of the IRC including recommendation 2.6c "...immediately authorize operational testing of the Air Force Compatibility Assessment, or similar tool, with a cross-Service pre-accession sample, allowing for important research and intervention development." While a more tailored measure is being developed, the Undersecretary of Defense for Personnel and Readiness (USD(P&R)) has requested each service investigate TAPAS as a predictor of unaccepted, non-adaptive behaviors including behaviors that are precursors to sexual assaults and sexual assault behaviors.

Task End State: At the request of USD(P&R), a validated assessment that fulfills recommendation 2.6c of the Independent Review Commission (IRC) on Sexual Assault in the Military

Dependencies: None Identified.

Task Measures of Effectiveness and Performance:

- Assessments have very defined success metrics based on professional and industry standards. TAPAS will demonstrate acceptable marginal reliability ($\alpha > .70$) and acceptable validity ($r = .20$) with unacceptable, non-adaptive behaviors. Both are aligned with best practices and current observations.

Army People Strategy: Military Implementation Plan 2.0

Milestones:

Milestone 1: Development of joint-service research design

Start date: FY23Q1; **End date:** FY23Q4

Milestone 2: Data collection and preliminary results of TAPAS for service compatibility

Start date: FY23Q4; **End date:** FY25Q4

Task 3.2.f: Validate Officer Assessments

OPR: USACC; **OCR:** ATMTF, ARI

Successful talent management relies on accurate information about individuals' specific talents, however during the implementation of officer talent management techniques and assessments the lack of an officer cognitive ability test and a more rigorous, more fake-resistant non-cognitive assessment was identified as a gap. ARI, in support of ATMTF, has initiated research to address these gaps by developing assessments that incorporate the most advanced technologies, such as the computer-adaptive administration format and Item Response Theory (IRT) scoring, to reflect the cognitive and non-cognitive attributes that officers need to be successful in their jobs as defined tailored by the Army Talent Attribute Framework's (ATAF) officer job analysis.

End State: Validated, robust, technologically enhanced cognitive and non-cognitive assessments are the foundation for officer talent management across an officer's career, from accessions decision to command selections, for the next several decades.

Dependencies: None Identified.

Task Measures of Effectiveness and Performance:

- Assessments have very defined success metrics based on professional and industry standards. The cognitive ability and non-cognitive assessments will demonstrate acceptable marginal reliability ($\alpha > .70$) and acceptable validity ($r = .60$ and $r = .25$) with job performance, respectively. Both are aligned with best practices and current observations.

Milestones:

Milestone 1: Identify and finalize cognitive items for assessment

Start date: FY23Q1; **End date:** FY23Q4

Milestone 2: Finalize non-cognitive items for assessment

Start date: FY23Q1; **End date:** FY24Q3

Milestone 3: Finalize prototype officer cognitive ability assessment

Start date: FY23Q1; **End date:** FY25Q4

Army People Strategy: Military Implementation Plan 2.0

Milestone 4: Field test officer non-cognitive assessment

Start date: FY23Q1; **End date:** FY25Q4

Objective 3.3: Onboard the Army

OPR: TRADOC; **OCR:** DCS G-1

Within the context of the APS, the objective of Onboarding is to: *Vet new Soldiers to maximize their productivity and establish the terms of their initial service with the Army.*

Critically, the Army Enterprise must set realistic expectations for these young people and provide opportunities for them to shape their careers. We must support them through their initial military training and attrit as few as possible.

Initial Military Training (IMT) is where the Army trains new recruits with the goal of maximizing their talent and military virtue as new Soldiers. Future Multi-domain Operations (MDO) will require optimum Soldier discipline and Soldiers that are physically, mentally, and medically ready to enter the operational force. To achieve this, IMT must be constantly evaluated for its effectiveness at maximizing Soldier discipline, physical fitness by examining *what* is trained, *who* does the training, and *how* the training occurs. For officers, the Army will explore ways to provide common cadet experiences before commissioning, establish better baseline officer qualifications and preparedness for leadership roles, and strengthen the sources of Army commissioning via mentors.

Objective Measures of Effectiveness and Performance:

- Percentage of recruits that finish initial training out of those who begin (goal: **increase**) (*Source: Training and Doctrine Command Combined Arms Center (TRADOC CAC)*)
- Percentage of recruits that attrit or are chaptered out prior to completion of initial training (goal: **decrease**) (*Source: TRADOC CAC*)
- Percentage of recruits that attrit by reason (*Source: TRADOC CAC*)
- Percentage of ROTC enrollees who continue past sophomore year to contract as cadets (goal: **increase**) (*Source: USACC*)
- Percentage of ROTC scholarship recipients who continue past sophomore year to contract as cadets (goal: **increase**) (*Source: USACC*)

Key Tasks:

Task 3.3.a: Prepare and Ship Successful Army National Guard Recruits

OPR: ARNG; **Data Owner:** ARNG

The current recruiting environment is comprised of many challenges, including a highly competitive civilian job market, COVID-19 vaccination hesitancy, a low propensity to serve, and diminishing population of eligible applicants. To prepare and ship successful ARNG recruits the Recruit Sustainment Program (RSP) must ensure warriors are mentally prepared, administratively correct, and physically fit to ship and thrive in Individual Entry Training (IET). The ARNG must also program IET and Basic Officer

Army People Strategy: Military Implementation Plan 2.0

Leaders Course (BOLC) training quota to achieve annual accessions missions and increase DMOSQ rates, as well as provide the appropriate support to the TRADOC Liaison program to ensure ARNG warriors onboard and complete IET.

Task End State: Army National Guard maintains a low attrition rate, decreases training pipeline losses, and assists the States, Territories, and D.C with strengthening their Recruit Sustainment Programs.

Dependencies: Task 3.2.a: Expand Specialized Recruiting Initiatives for the Army National Guard

Task Measures of Effectiveness and Performance:

- Maintain at (or above) 84% Enlisted Training Pipeline Success Rate and at (or above) 94% Initial Active-Duty Training Success Rate.
- Not more than 5% losses at training
- Review LNO trend data quarterly to assess current policy implementation, improve Shipper QC, and reduce administrative issues.

Milestones:

Milestone 1: Continue to reduce At-Training Loss to less than 3% of Attrition losses.

Start Date: FY23Q1; **End Date:** FY25Q4

Milestone 2: Improve to 85% Training Pipeline Losses (TPL) rate.

Start Date: FY23Q1; **End Date:** FY24Q4

Milestone 3: Have conducted 100% of RSP accreditation.

Start Date: FY23Q1; **End Date:** FY25Q4

Task 3.3.b: Implement initiatives meant to combat harmful behaviors in IET

OPR: TRADOC; **Data Owner:** Center for Initial Military Training (CIMT)

As the Gateway to the Army, IET provides a New Soldier Experience that facilitates a positive first impression of Army service. Only within an environment built upon dignity and respect can we build Army Families, teach life skills, make a connection between cadre and trainees, and ultimately reduce harmful behaviors.

Dependencies: None Identified.

Task Measures of Performance/Effectiveness:

- Changes from recurring Basic Combat Training (BCT) Program of Instruction (POI) reviews are captured and codified every 24 months.
- Adopt applicable best practices and lessons learned from the other Services into the IET framework.
- Cadre Resiliency Program implementations strengthen Drill Sergeant and Cadre community resilience.

Army People Strategy: Military Implementation Plan 2.0

Milestones:

Milestone 1: Review, assess, and update BCT POI for inclusion of prevention of harmful behavior initiatives as identified by proponents

Start Date: FY23Q1; **End Date:** FY25Q4

Milestone 2: Integrate inter-service harmful behavior and prevention knowledge gained through participation in the Council on Recruit Basic Training (CORBT) into IET.

Start Date: FY24Q1; **End Date:** FY25Q4

Milestone 3: Assess the impact of attrition reduction initiatives.

Start Date: FY24Q1; **End Date:** FY25Q4

Task 3.3.c: Reduce medical issues through TRADOC Organic Medical Structure (TOMS)

OPR: TRADOC; **Data Owner:** TRADOC SURG

Implement TOMS to deliver appropriate, competent, and timely medical care to effectively and efficiently train and lead Soldiers to enter the operational force and maximize Army mission readiness. TOMS is complementary to Holistic Health and Fitness (H2F) and Medical Research Development (MRD), with “forward” medical care in training brigades (BDE) and battalions (BN), with the expectation that closer proximity to primary healthcare will improve/sustain Soldier medical readiness, performance, and resilience while in TRADOC formations.

Task End State: All necessary resources are in place and TOMS is Full Operational Capability (FOC); Generate physically, mentally, and medically ready Soldiers to enter the operational force.

Dependencies: None Identified.

Task Measures of Effectiveness and Performance:

Measures of Performance:

- Reduction of Lost Program of Instruction (POI) Time

Measures of Effectiveness:

- Reduction of Initial Entry Training Attrition

Milestones:

Milestone 1: TOMS program at Full Operational Capability (FOC) at BCT, OSUT, and Training BDEs.

Start Date: FY23Q1; **End Date:** FY24Q4

Army People Strategy: Military Implementation Plan 2.0

Milestone 2: TOMS program at Full Operational Capability (FOC) at Advanced Individual Training (AIT), USAREC, and USACC.

Start Date: FY25Q1; **End Date:** FY26Q4



Chapter 4: Develop Talent
Military Implementation Plan 2.0

Army People Strategy: Military Implementation Plan 2.0

Develop Talent LOE

Lead Integrator: Training and Doctrine Command Combined Arms Center (TRADOC CAC)

Introduction: By 2030, the Army will educate, train, and credential the talent needed for the multi-domain force envisioned in the *Army Strategy*. We must identify employment, education, and training opportunities which will extend each Army professional's talents, close talent gaps, and maximize their contributions to the Total Army. The Army must continually develop its Soldiers. In addition to placing Soldiers in positions of greater responsibility, the Army must develop leaders who possess the character, competence, and commitment to serve in the Army Profession.

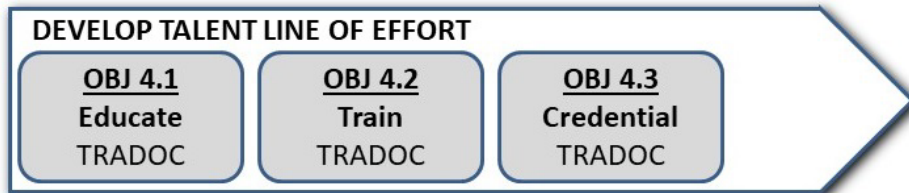

Figure 5: Develop Talent APS Line of Effort

The Army's Mission is unchanged – to deploy, fight, and win the nation's wars. However, war is an inherently human endeavor. As the Army modernizes its materiel solutions and organizations to maintain its competitive advantage in a rapidly changing operational environment to win in Large Scale Combat Operations against peer threats, the Army must also modernize how it develops its primary weapons—Soldiers and leaders.

Modernized leader development, military education, increased advanced civil schooling opportunities, and credentialing will align Knowledge, Skills, and Behaviors (KSBs) for each branch, rank, and position that will be coupled with a continuous assessment process maximizing an individual's talents, building the appropriate level of warfighting skills, and targeting the individual's development.

Figure 6: Develop Talent LOE Strategic Outcomes

The Army will implement the Develop Talent Line of Effort by achieving these six strategic outcomes:

1. The Army implements enduring and evolving career long assessments
2. The Army instills the Army Profession by improving PME
3. The Army modernizes and inculcates career long leader development
4. The Army continuously incorporates emerging technologies into training and education
5. The Army maximizes Credentialing opportunities for Soldiers
6. The Army modernizes doctrine to support requirements in Multi-Domain environments

Army People Strategy: Military Implementation Plan 2.0

(APS Near-Term Priority #5) - Research, design, and pilot a suite of talent assessments for Soldiers and Civilians for future scaling.

Develop Talent LOE End State: Over time, leaders grow their ability to see themselves and understand how others see them as leaders to improve based on validated benchmarks of physical fitness, leadership, cognition, communication, mental toughness / interpersonal skills, and level of professional knowledge. Senior leaders routinely informed of status and trends on leader effectiveness to track progress towards the Army Strategy, Army People Strategy and Army Training and Leader Development Strategy ends to facilitate strategic decisions. The ultimate enduring result is leaders and teams of leaders who are members of and form cohesive teams that are trained, disciplined, and fit, and ready to win on the battlefield.

Objective 4.1: Educate the Army

OPR: TRADOC; **OCR:** AWC/ATMTF

Within the context of the APS, the objective of Education is to: *Revise the current system of progressive, continuous, and deliberate professional military and civilian education, to include advanced civil schooling. Incorporate a culture of talent assessments into military and civilian educational and leader development efforts. Educate Army human resources professionals and senior leaders in the art and science of talent management.*

Army efforts in education are certainly much broader than those addressed in the APS. Focusing on the APS definition focuses attention on the evolving space of talent assessment and corresponding changes to how we educate and assess Soldiers.

Objective End State: Talent Management is incorporated into Army Professional Military Education (PME) thus building short- and long-term readiness while promoting a culture of lifelong leader development.

Objective Measures of Effectiveness and Performance:

- Percentage of Human Resources, Primary Military Education, and Direct Reporting Unit-directed curricula incorporating Talent Management training out of the number expected to do so (goal: **increase**) (Source: TRADOC CAC/COEs/Army War College)
- Number of students that received such training (Source: TRADOC CAC/CoEs/Army War College)
- Number of hours of such training provided per Soldier (Source: TRADOC CAC/CoEs/Army War College)
- Percentage of the total force that participated in a diagnostic assessment via Project Athena out of the number eligible (Source: TRADOC CAC)

Key Tasks:

Army People Strategy: Military Implementation Plan 2.0

Task 4.1.a: Adapt and Implement Learning Products to Rapidly Account for Changes in the Operational Environment (OE)

OPR: TRADOC CAC; **OCR:** TRADOC, COEs; **Data Owner(s):** Army University and Centers of Excellence (COEs) (Aviation, Cyber, Fires, Intelligence, Maneuver Support, Medical, Non-Commissioned Officer (NCO) Leader, Sustainment, and Special Operations)

Task End State: Agile and adaptive learning products incorporating emerging learning technologies preparing leaders for increased responsibilities while honing mission command and leadership skills required for success in LSCO in a Multi-Domain Operations (MDO) environment.

Dependencies: POM funding to support course growth to capture emerging requirements and technologies in Professional Military Education (PME) Common Core. Data demonstrates that a culture of assessments and self-development have taken firm root in the U.S. Army.

Task Measures of Effectiveness and Performance:

Measures of Performance:

- Learner-centric approach. The primary approach to ensure PME adaptation and continuity in Army learning is to focus on the learner, whether individual or team.
- Increase in number of research papers written and published focused on rapid changes in the operational environment.
- The rapid implementation of an adaptive and continuous career-long learning model, move away from episodic individual learning events where Soldiers periodically participate in resident or non-resident courses that are not sequential and progressive.
- Develop and execute education and training (institutional and self-development) that uses new and emerging doctrinal publications and enhances competencies individuals gain through the operational domain.
- Provide a complex, realistic learning environment, virtual, constructive, and gaming must converge into a common training simulation for the operational, institutional, and self-development training domains across all echelons.
- Operational Enterprise Classroom Program (ECP) classrooms completed to provide learner-centric environments.
- Engage students in frequent context-based problem-solving exercises.
- Encourage peer-to-peer learning and maximize Students' operational experiences to influence the nature and complexity of classroom and distributed learning experiences.
- Develop pilot exercises using Common Scenario Exercise Program (CSEP) that links and nests professional military education courses at the Centers of Excellence (CoE) and Command and General Staff College (CGSC) with a series of operations orders and annexes from corps to platoon levels.

Army People Strategy: Military Implementation Plan 2.0

Measures of Effectiveness:

- Increased Army Senior Leader dialogue on TP 525-8-2, Army Learning Concept 2035 (ALC).
- Apply the rapid curriculum development process and rapid prototyping to facilitate updating lessons within three-months of new doctrine published. Lesson plans in professional military classes will process waivers as necessary. New lessons will be included in the next POI cycle. Analysis must occur between proponents and the CoEs to properly integrate emerging requirements into Common Core.
- Forecast proper contracting requirements with The Army Distributed Learning Program (TADLP) on time in to keep all DL courses current and relevant (within 2-3 years). An essential element of the DL courseware and content development process is to select the most effective technique to present the learning products. As communications capabilities and multimedia technologies constantly evolve, TADLP will incorporate state-of-the-art delivery technologies that are cost and instructionally efficient to satisfy requirements.
- Establish Digital Learning Lab (DLL) to support the various DL modernization efforts of the schools. Adapt and implement learning products to rapidly account for changes in the Operational Environment (OE).

Milestones:

Milestone 1: Enable new talent to arrive and achieve necessary PME requirements to be both effective and competitive within their assigned cohort year group.

Start Date: FY22Q1; **End Date:** FY24Q4

Milestone 2: Conduct research and publish papers of emerging trends in learning theory and methods, cognitive sciences, knowledge/skills/behaviors, learning and enabling technologies, design, and governance.

Start Date: FY22Q1; **End Date:** FY24Q4

Milestone 3: Develop process to enable revised lesson plans to be available for implementation within three months of OE driven doctrinal changes.

Start Date: FY22Q1; **End Date:** FY24Q4

Milestone 4: Develop, staff, and gain approval of TP 525-8-2, Army Learning Concept 2035 (ALC) then update every five years.

Start Date: FY22Q1; **End Date:** FY23Q4

Milestone 5: Submit resource requirements for the Enterprise Classroom Program (ECP) through the Program Objective Memorandum (POM). Currently 2/3 of ECP is funded through unfinanced requirements (UFRs). Update institutional systems to support implementation of modernized learning technologies.

Start Date: FY22Q1; **End Date:** FY25Q4

Army People Strategy: Military Implementation Plan 2.0

Milestone 6: Develop processes to enable enhanced review and revision of Distributed Learning lesson products for use within three months of OE driven doctrinal changes. Identify and present to the Army Learning Coordination Council (ALCC) FY22 & 23 quick wins (to be determined) that can be accomplished within existing resources.

Start Date: FY23Q1; **End Date:** FY23Q4

Milestone 7: Develop a Common Scenario Exercise Program (CSEP) that is in sequence and, when available, networks Mission Command Systems, and links professional military education courses at the Centers of Excellence (CoE) and Command and General Staff College (CGSC) to a nested series of operations orders and annexes from corps to platoon levels. Sunset old and implement new training and education technologies as directed by Army Capabilities Managers (ACM).

Start Date: FY22Q1; **End Date:** FY23Q4

Milestone 8: TRADOC CAC Army University supports Army Training Information System (ATIS) development by representing functional proponency for learning requirements to capture knowledge, skills, and behaviors (KSBs) from professional military education (PME), voluntary education (VOLED), and credentialing as a single, authoritative data source to drive talent management systems.

Start Date: FY21Q1; **End Date:** FY27Q4

Task 4.1.b: Collaborate with Academia

OPR: TRADOC CAC; **Data Owner:** Vice Provost for Academic Affairs, Army University

The Army lacks a programmatic approach to academic collaboration to develop talent, exchange academic administration and learning best practices, conduct research, provide credit for military learning, expand public private partnerships, and enhance the overall educational experience and expertise within the Joint and Army learning environment to enable the Army to sustain intellectual and technical overmatch of its adversaries.

Dependencies: Table of Distributions and Allowance (TDA) positions maintained to perform organizational functions. POM funding to support travel.

Task Measures of Effectiveness and Performance:

Measures of Performance:

- Two major research initiatives executed per year.
- Biennial Army Learning Symposiums conducted.
- Two Journal for Military Learning (JML) publications per year.
- Up to five focus group events conducted per year to identify and promulgate best practices.
- Five professional symposiums and conferences attended per year.
- 20 professional association memberships maintained per year.

Army People Strategy: Military Implementation Plan 2.0

- Up to two fully funded academic exchange opportunities per TRADOC School per year.

Measures of Effectiveness:

- A strong network established of academic institutions, effective applied learning sciences research, and professional affiliations enabling rapid adaptation of the institution in support of the operational force.
- Academic communities of practice established that support credit for military learning, the professional exchange of ideas, faculty exchanges, cooperative research, active participation in professional associations, attendance and presentation at academic symposiums and conferences, publication of a peer reviewed Journal of Military Learning, and hosting of a recurring symposium for Army Learning.

Milestones:

Milestone 1: Execute an Army University Research Program overseen by the Army Learning Coordination Council, to pursue research of advances in learning sciences and current/relevant military topics. (Army Learning Coordination Council (ALCC) approved annual research agenda through 2030).

Start date: FY21Q1; **End date:** FY28Q4

Milestone 2: Conduct reoccurring biennial Army Learning Symposium to further develop partnerships with domestic and international academia and inform the Army Learning Concept for 2035.

Start date: FY21Q1; **End date:** FY28Q4

Milestone 3: Publish editions of the *Journal for Military Learning* (JML) as a peer reviewed journal overseen by an editorial board consisting of military and civilian academic professionals.

Start date: FY21Q1; **End date:** FY28Q4

Milestone 4: Expand public/private partnerships supporting the adoption of relevant best practices to improve the Army University systems.

Start date: FY21Q1; **End date:** FY28Q4

Milestone 5: Identify and attend up to five critical symposiums and conferences.

Start date: FY21Q1; **End date:** FY28Q4

Milestone 6: Identify up to 20 key professional associations for funded memberships.

Start date: FY21Q1; **End date:** FY28Q4

Milestone 7: Fund academic exchange opportunities between civilian and military learning institutions.

Army People Strategy: Military Implementation Plan 2.0

Start date: FY21Q1; **End date:** FY28Q4

Task 4.1.c: Develop a coordinated Army Learning Concept and Army Training Concept.

OPR: TRADOC CAC; **Data Owner:** Vice Provost for Academic Affairs, Army University

The Army lacks a comprehensive learning concept that sets the direction for empowering learners and leveraging technology to meet the Army's learning requirements. Having such a concept will enable the Army to sustain intellectual overmatch of adversaries, manage talent as the enduring strategic advantage to create operational adaptability, and expand the competitive space within MDO to win in a complex world.

Dependencies: TDA positions maintained to perform organizational functions. POM funding of required capabilities.

Task Measures of Effectiveness and Performance:

Measures of Performance:

- Research reports of trends complete and published.
- Publish TP 525-8-2, Army Learning Concept 2035.
- Required Capabilities validated in Joint Capabilities Integration and Development System (JCIDS).
- "Quick Wins" approved by ALCC (UFR submitted if required).
- New training and education technologies implemented with increases in technology effectiveness and efficiency.
- Changes result in increased learning: effectiveness (Rigor and Relevance); efficiency (Dollars, Manpower, Infrastructure, etc.); velocity (Speed of learning and delivery of learning); accessibility (Pervasiveness); adaptation; support of talent management (developing and managing talent).
- Implementation and lifecycle plan fully funded by POM.

Measures of Effectiveness:

- A dynamic Army Learning Concept that evolves with advancements in learning methodologies and technologies to meet the current and evolving learning demands of MDO.
- A Holistic Individual Learning Concept of career-long learning that is learner-centric, tailored to individuals, and delivered across diverse locations, media, and periods of time.
- Improved measures and analyses to optimize this system-of-systems and drive continuous adaptation and optimization across it.
- The system's technological foundation is an 'internet for learning' that not only allows ubiquitous access to learning, it also provides pathways for optimizing individual and workforce development at an unprecedented pace.

Milestones:

Army People Strategy: Military Implementation Plan 2.0

Milestone 1: Conduct research and publish papers of emerging trends in learning theory and methods, cognitive sciences, Knowledge/Skills/Behaviors, learning and enabling technologies, design, and governance.

Start date: FY21Q1; **End date:** FY28Q4

Milestone 2: Update every five years: Develop, staff, and gain approval of TP 525-8-2, Army Learning Concept 2035 (ALC) then update every five years.

Start date: FY21Q4; **End date:** FY28Q4

Milestone 3: Submit ALC 2035 Required Capabilities to the Joint Capabilities Integration and Development System (JCIDS) process, then update every year.

Start date: FY21Q4; **End date:** FY28Q4

Milestone 4: Identify and present to the Army Learning Coordination Council (ALCC) FY22 & 23 quick wins (TBD) that can be accomplished within existing resources.

Start date: FY21Q4; **End date:** FY22Q4

Milestone 5: Submit resource requirements through the Program Objective Memorandum (POM).

Start date: FY22Q1; **End date:** FY24Q4

Milestone 6: Sunset old and implement new training and education technologies as directed by Army Capabilities Managers (ACM).

Start date: FY22Q1; **End date:** FY24Q4

Milestone 7: Track changes in key areas of the learning concept and adjust as required.

Start date: FY22Q1; **End date:** FY28Q4

Task 4.1.d: Develop and Implement Talent Management training into PME venues across the Force

OPR: TRADOC; **OCR(s):** Army Talent Management Task Force; **Data Owner:** TRADOC, USMA, AWC

Task End State: The art and science of Talent Management is incorporated into Army Professional Military Education (PME) thus building short- and long-term readiness while promoting a culture of lifelong leader development.

Dependencies: Identify the percent of PME courses that have incorporated Talent Management focused content into their curriculum.

Task Measures of Effectiveness and Performance:

Measures of Performance:

Army People Strategy: Military Implementation Plan 2.0

- Expanded education on Talent Management including the facilitation and understanding of concepts/initiatives throughout PME venues
- Council of Colonels (AU) conducts pre-staffing of the Talent Management Implementation Plan and Learning Strategy
- TRADOC TASKORD is published for dissemination throughout PME venues

Measures of Effectiveness:

- Talent Management is fully incorporated in HR Professionals Common Core curriculums and PME venues
- Talent Management concepts and initiatives are incorporated into current curriculums throughout PME (BOLC, WOBC, CCC, ILE, SSC, PCC, SLC, MLC, Non-Commissioned Officer Leadership Center of Excellence (NCOLCoE)).

Milestones:

Milestone 1: Incorporate initial Talent Management principles, concepts and initiatives into curriculums throughout PME venues. Provide SSI with Talent Management content for curriculum development for HR Professionals.

Start date: FY21Q1; **End date:** FY23Q4

Milestone 2: Development of the Talent Management Implementation Plan and Learning Strategy.

Start date: FY22Q3; **End date:** FY22Q3

Milestone 3: Develop and implement Talent Management Common Core curriculum; outlining principles, concepts and initiatives for HR Professionals and senior leader PME venues (BOLC, WOBC, CCC, ILE, SSC, PCC, SLC, MLC, NCOLCoE). Implement exportable training packages and learning resources for self-development.

Start date: FY21Q1; **End date:** FY23Q4

Milestone 4: Fully adapted awareness of Talent Management principles, concepts, and initiatives throughout PME venues.

Start date: FY23Q1; **End date:** FY28Q4

Task 4.1.e: Increase Soldier Success in Voluntary Education Programs

OPR: TRADOC

The Army Credentialing and Continuing Education Systems for Soldiers (ACCESS) provides lifelong learning, readiness, and resilience through flexible and quality education programs, services, and systems in support of the Total Army. Voluntary Education (VOLED) programs include education counseling, Basic Skills Education Program (BSEP), Army Personnel Testing (APT), military training evaluation program, Academic Testing, Joint Service Transcript (JST), the Army Credentialing Program, and the Tuition Assistance (TA) program which funds Soldiers' pursuits of postsecondary education. Opportunity exists to improve ACCESS programs by increasing Soldier

Army People Strategy: Military Implementation Plan 2.0

participation and success in VOLED as they work towards and complete their academic degrees and credentials.

The Army's goal is 30% of eligible Soldiers use TA in pursuit of voluntary education. Eligible Soldiers are considered those who have not completed a graduate program although Soldiers with a graduate degree are still eligible to complete an academic certificate program. Currently, the participation rate for the Active Component is approximately 20%, the ARNG is 5%, and the USAR is 4%. When using TA for college courses, Soldiers will be recouped if they do not achieve acceptable grades. Per DODI 1322.25 (Voluntary Education Programs), acceptable grades are defined as A, B, or C for undergraduate courses, and an A or B for graduate courses. The OSD goal for all Services is a 92% acceptable grade rate for TA funded courses. The FY19 acceptable course completion rate for the Army was 88%. By meeting proposed milestones below, the Army can increase Soldier participation and acceptable course completion grade rates. The ultimate goal of VOLED is for Soldiers to establish, work towards and then complete one or more academic degrees, certificates and/or credentialing programs aligned with their needs and interests. A typical Associate's degree is 60 semester hours and a Bachelor's degree is 120 semester hours. In FY20, 8766 Soldiers completed certificates and degrees. By improving VOLED services and programs, the Army can assist Soldiers in advancing their postsecondary education and earning their degrees.

Task End State: Increased participation in the VOL ED program and increased rates of degree completion. ACCESS programs and services support the self-development domain of the Army leader tenets by providing opportunities to Soldiers for traditional and technology-based education, and support for personal and professional career goals. Education develops critical thinking and decision-making skills enabling Soldiers to be better leaders and adapt to new challenges. VOLED opportunities enhance job performance, skill qualifications, career growth, and supports Soldiers as they transition into the civilian workforce.

Dependencies: None Identified.

Task Measures of Effectiveness and Performance:

- Goal: 30% of eligible Soldiers (all ranks) participate in voluntary education and/or credentialing using TA.
- Army successful course completion rate: 92% for TA-funded college courses.
- Soldiers progressively work towards a college degree: percentage of Soldiers that use TA to earn an Associate degree increases each year and percentage of Soldiers who use TA to earn a Bachelor's degree increases each year.
- Soldiers who fail courses are counseled and limited in further participation until their GPA is raised.

Army People Strategy: Military Implementation Plan 2.0

Milestones:

Milestone 1: Review the TA policy to identify areas for improvement to provide better support to Soldiers and improve the acceptable course completion grade rate.

Start date: FY23Q1; **End date:** FY23Q4

Milestone 2: Implement the existing AMC/IMCOM Education Services Officer course taught by IMCOM Army Continuing Education System.

Start date: FY23Q1; **End date:** FY23Q4

Milestone 3: Draft DA PAM 621-5 to provide ACCESS VOLED programs procedural guidance including, but not limited to: Soldier responsibilities, counselor procedures, and ArmyIgnitED processes.

Start date: FY23Q1; **End date:** FY23Q4

Milestone 4: Draft a revised AR 621-5.

Start date: FY23Q1; **End date:** FY23Q4

Milestone 5: Publish DA PAM 621-5.

Start date: FY24Q1; **End date:** FY24Q4

Milestone 6: Publish AR 621-5.

Start date: FY24Q1; **End date:** FY24Q4

Milestone 7: Complete final requirements for the ArmyIgnitED system in support of the TA program in 23 and continue to refine for greater usability.

Start date: FY23Q1; **End date:** FY25Q4

Task 4.1.f: Career Mapping and Succession Planning Tool (CMSP-T)

OPR: ATMTF / pending transition ownership (working); **Data Owner:** IPPS-A

Career Mapping and Succession Planning Tool (CMSP-T) aims to operationalize the Army Talent Attribute Framework (ATAF) as a proof of concept through the application of an interactive career mapping capability based on a competency alignment algorithm that will leverage Knowledge, Skills, Behaviors, and Preferences (KSB-P) data. This algorithm will deliver a dynamic comparison of the KSB-Ps possessed by individual(s) (in a point in time) against minimum KSB talent requirements needed to effectively execute follow-on/future job assignment(s), to include any talent gaps.

Task End State: CMSP-T (1) operationalizes the ATAF as a proof of concept; (2) establishes the necessary business processes repeatable to scale (across all Army jobs) and tailor (other initiatives); and (3) leverages AI/Machine Learning (ML) to provide data-rich talent alignment analysis to impact future Army Talent Management (TM) decisions. Preliminary utility of this tool informs & educates career development and

Army People Strategy: Military Implementation Plan 2.0

marketplace employment decisions for both individuals and hiring authorities, and integrates ArmyGovCloud platform with Army systems (i.e., IPPS-A, talent applications and assessment data); and have future implications to host career mobility, increase talent alignment, and support talent retention critical to the overall success of the Army.

Dependencies: FOC requires workforce talent data identifying KSB requirements by position for branch-specific and immaterial positions. ARI/ATMTF workforce job analysis results will produce some of this information, which will require branch proponent review and adoption into existing Army processes for determining personnel attribute requirements.

Task Measures of Effectiveness and Performance:

Measures of Performance:

- FY22: MOP – (1) tool feedback survey.
- FY23: MOP – (1) tool feedback survey, (2) tool utilization statistics.
- FY24: MOP – (1) tool feedback survey, (2) tool utilization statistics.

Measures of Effectiveness:

- FY23: MOE – Collect data on individuals that utilized the tool for longitudinal study.
- FY24: MOE – Conduct longitudinal study of individuals that utilized the tool to inform their (1) assignment selection(s) and measure their performance & satisfaction of assignment, and/or (2) professional development and measure their growth & satisfaction.
- FY24 & beyond: MOE – Ongoing study will be required to measure ways of impact and success in the following areas:
 - Acquire Talent – leverage talent gap data to inform Army acquisition (i.e., Direct Commission).
 - Develop Talent – (1) identify individual talent gap(s) to recommend educational, training, coaching, counseling, and credentialing opportunities (i.e., ArmyIgnitEd, distance learning, Army Coaching Program, Developmental Counseling, Army COOL (Credentialing Opportunities On-Line) and other credentialing approved sites); and (2) collective talent gap(s) can also inform leaders on developmental opportunities to focus via training plans & Officer Professional Development.
 - Employ Talent – (1) inform marketplace decisions to align talents & careers; and (2) integrate other programs & initiatives (i.e., compensation programs, Exceptional Family Members Program (EFMP), Married Army Couples Program (MACP), Spouse Education & Career Opportunities (SECO)), to align both KSB (professionally) and preferences (personally).
 - Retain Talent – (1) provide Individual Development Plans (IDP), and integrate career counseling & coaching programs at crossroads along that path, then we can support engagement opportunities for retention, incentives, and workforce permeability (current contract platform is Service Now, same platform as Civilian Human Resources Agency (CHRA)'s build for civilian talent); and (2) establish talent data-rich environment that will provide hiring authorities (and ASL) Succession Planning potentials of scouting 3-5 years down the talent pipeline for

Army People Strategy: Military Implementation Plan 2.0

MDOs or specific in-demand talents (e.g., for senior leaders, emerging technology fluency), and engage target retention incentives (i.e., tailored compensation packages, service permeability, brevet promotion).

Milestones:

Milestone 1: Identify a capability solution and set conditions.

Start date: FY21Q1; **End date:** FY21Q4

Milestone 2: Develop business processes for MVP (minimum viable product) with capability to scale (across all Army jobs) and tailor (other initiatives).

Start date: FY22Q1; **End date:** FY22Q4

Milestone 3: Scale MVP across all Army officers & branches and integrate with other TM initiatives.

Start date: FY23Q1; **End date:** FY23Q4

Milestone 4: Implementation of project into IPPS-A environment and development of FOC.

Start date: FY24Q1; **End date:** FY24Q4

Task 4.1.g: Emerging Technology Leaders (ETL)

OPR: TRADOC CAC; **OCR:** AFC, ASA(M&RA), ASA(ALT); **Data Owner:** Army Software Factory, Artificial Intelligence Integration Center, AFC Applications Group

The twenty-first century operational environment is complex and spans multiple domains. The Army will require an innovative way to maximize the strength of the nation to maintain a competitive edge. The Army must create a fluid system to acquire, develop, employ, and retain uniformed experts that conduct research, integrate, and accelerate technology for the Army across several emerging fields. An Emerging Technology Leader (ETL) is a uniformed expert that conducts research and helps integrate / accelerate technology into the Army against emerging fields. An ETL should be able to dialogue with operational forces to gain valuable insight and assess requirements for Army investment. ETLs can fill critical roles in Army research labs and centers, advise leaders and troops at ACOMs to better understand and integrate technology, STEM faculty at USMA, and conduct technology fellowships in industry.

Task End State: The vision is to build cohesive teams for the Joint Force by maximizing the talents of people, the Army's greatest strength and most important weapon system. Skills and capabilities in AI, Software Development, Data Analytics, and other emerging fields and disciplines are integrated across the Army at the appropriate echelon, enabling leaders to make better decisions faster on the complex and highly lethal battlefield of the future.

Dependencies: None Identified.

Army People Strategy: Military Implementation Plan 2.0

Task Measures of Effectiveness and Performance:

- Percentage of AIM resumes with KSBs increases annually
- Percentage of AIM position descriptions with KSBs increases annually
- Number of self-development learning resources available across all grade plates and cohorts
- Use of NDAA19 authorities (e.g., Direct Commission, Alternate Promotion Authority, Brevet promotions).
- Increased number of eligible officers for ETL opportunity (KSB).
- Increased number of fully funded programs educational/experiential programs to support ETL (TWI, tech Scouts, Grad School).
- Changes in the traditional career path (assignments, locations).

Milestones:

Milestone 1: Develop Knowledge, Skills, and Behaviors (KSB) for ETL.

Start date: FY22Q2; **End date:** FY24Q1

Milestone 2: To establish pathways and proponent partnership for Soldiers lifecycle management system.

Start date: FY22Q3; **End date:** FY24Q1

Milestone 3: Develop entries to update DA PAM 600-3/611-21/350-1.

Start date: FY23Q1; **End date:** FY25Q4

Milestone 4: Identify and recommend intermediate level education credentialing graduate programs.

Start date: FY22Q3; **End date:** FY24Q1

Milestone 5: AI and SW skills and capabilities are documented and appropriately resourced in the future force.

Start date: FY22Q3; **End date:** FY25Q4

Task 4.1.h: Implement Professional Growth Counseling into Career Milestones for Officers and Warrant Officers

OPR: TRADOC; **Data Owner:** TRADOC

Title 10 §656 requires each service to establish an officer counseling system that begins in the cadet years and continues throughout an officer's career. This counseling system must be offered to all officers and should address career fields, promotion rates, and optimize the officer's ability to make informed career decisions throughout their career. Currently, the Army does not have a counseling program in place that meets this requirement.

Dependencies: Individual Developmental Plans (IDPs) capability in Army Career Tracker (divesting) and Army Training Information System (gaining)

Army People Strategy: Military Implementation Plan 2.0

Task Measures of Effectiveness and Performance:

Measures of Performance:

- Counseling sessions executed are meeting the required counseling sessions approved by ASLs in the counseling plan of action.
- Army officer career counseling program meets the performance standards established by Title 10 §656.

Measures of Effectiveness:

- System identified to capturing counseling as outlined in Title 10 §656.
- Counseling system provides statistics on completion of individual counselling across personnel diversity measures.
- Accountability measures are collected to inform leadership
- Outcomes of inclusion and diversity improve force readiness

Milestones:

Milestone 1: Gain ASL approval of need's analysis, new regulation(s) or updates to existing regulation(s) mandating professional growth counseling programs that meet requirements from Title 10 §656.

Start date: FY23Q1; **End date:** FY23Q4

Milestone 2: Implement ASL approved professional growth counseling plan of action. Educate the force through PME about mandated professional growth counseling and monitor implementation.

Start date: FY24Q1; **End date:** FY28Q4

Task 4.1.h1: Identify System of Record to Capture Officer and Warrant Officer Career Developmental Counseling

OPR: TRADOC CAC; **Data Owner:** TRADOC

Title 10 §656 requires each service to establish an officer counseling system that begins in the cadet years and continues throughout an officer's career. Currently AR 350-1 designates the Army Career Tracker (ACT) as the system of record to track completion of Individual Developmental Plans (IDPs) and has already identified Army Training Information System (ATIS) as the gaining system which will onboard IDPs by FY25.

Dependencies: Task 4.1.h: Implement Professional Growth Counseling into Career Milestones for Officers and Warrant Officers, Individual Developmental Plans (IDPs) standardization, SOR capability in Army Career Tracker (divesting) and Army Training Information System (gaining)

Task Measures of Effectiveness and Performance:

Measures of Performance:

- IDP Completion rate meets the requirements specified in AR 350-1

Army People Strategy: Military Implementation Plan 2.0

Measures of Effectiveness:

- Army officer career counseling system of record supports the counseling gates established in Task 4.1.h: Implement Professional Growth Counseling into Career Milestones for Officers and Warrant Officers and AR 350-1.
- Army officer career counseling system of record supports the requirements established in Title 10 §656

Milestones:

Milestone 1: Develop Business Process and associated data dictionary for “Conduct professional growth counseling” in ACT /ATIS

Start date: FY22Q1; **End date:** FY23Q4

Milestone 2: Implement Changes and Educate the Force

Start date: FY23Q1; **End date:** FY27Q4

Objective 4.2: Train the Army

OPR: TRADOC; **OCR:** M&RA

Within the context of the APS, the objective of Training is to: *Develop and implement new tools, methods, and processes to enhance individual talents for the benefit of the Army and the individual. Invest in the development of Army leaders and supervisors who will provide purpose, motivation, and direction to meet the MDO-capable force objectives by 2035.*

As with education, Army efforts in the area of training are broader than those addressed in the APS. The APS definition focuses attention on talent enhancement and the development of tools and methods to do so. MDO-capable force objectives include expansion of the portion of the force with ASIs and other critical skills, especially with regards to technology/cyber and arctic capabilities.

Objective End State: Use modern, efficient methods of training to help Soldiers develop their careers and prepare the Army for the future fight.

Objective Measures of Effectiveness and Performance:

- Percentage of training courses with a 90% pass rate (goal: **increase**) (Source: TRADOC CAC)
- Percentage of total force that has an ASI (Source: HRC)

Key Tasks:

Task 4.2.a: Enhance Leader Effectiveness Through Assessments

OPR: TRADOC CAC; **Data Owner:** Center for the Army Profession and Leadership (CAPL)

Army People Strategy: Military Implementation Plan 2.0

Improve Army leader effectiveness using web based developmental assessments and automated feedback reports, and learning tools aligned with leadership and leader development doctrine for use in Professional Military Education (PME), Home Station (HS), Combat Training Centers (CTCs) and Deployment training / operations.

Dependencies: POM support continues for Army Enterprise Assessment Program (AEAP). Data demonstrates that a culture of assessments and self- development have taken firm root in the U.S. Army

Task Measures of Effectiveness and Performance:

Measures of Performance:

- Army Enterprise Assessment System (AEAS) available 24/7/365 with web-based assessments available at 98% of the time.
- Annual Army-wide report on leader effectiveness delivered to ASLs and briefed at the Army Profession Forum.
- Quarterly, Strategic Readiness Tenet 5 Leading's Leader Effectiveness Indicator is updated based on CAPL's Annual Survey of Army Leadership (CASAL) and Project Athena's Leader 360 and Leader 180 data.
- Annually, six new or revised assessments for Project Athena completed. Leadership Assessments fielded on schedule.
- Annually, eight Brigade-level Unit 360 assessments completed.
- Annually, 50 Commander 360 assessments completed.

Measures of Effectiveness:

- Project Athena assessments and feedback reports validated for effectiveness and available on AEAS.
- Aggregate scores in the areas of physical fitness, leadership, mental horsepower, communication, mental toughness/interpersonal skills, and leader's level of professional knowledge increase over time as reported by Branch schools, and data from Project Athena assessments.
- Longitudinal studies show increase in the areas of leader effectiveness, command climate and readiness.

Milestones:

Milestone 1: Sustain the Army Enterprise Assessment Program (AEAP) and its supporting IT backbone (AEAS) as a key enabler to support Project Athena and promote a culture of assessments across the Army.

Start date: FY23Q1; **End date:** FY25Q4

Milestone 2: In accordance with HQDA EXORD execute Project Athena across resident PME.

Start date: FY23Q1; **End date:** FY25Q4

Army People Strategy: Military Implementation Plan 2.0

Milestone 3: Conduct annually a survey (CASAL) of leader perceptions of the quality of their leader's leadership, their own development as leaders and special leadership topics.

Start date: FY23Q1; **End date:** FY25Q4

Milestone 4: Field and maintain assessments, feedback reports and learning tools for the operational force to improve unit leadership development.

Start date: FY23Q1; **End date:** FY25Q4

Task 4.2.b: Integrate Emerging Technologies into Training

OPR: Training and Doctrine Command Combined Army Center – Training (TRADOC CAC-T); **OCR:** AFC; **Data Owner:** TRADOC CAC-T

Dependencies: None Identified.

Task Measures of Effectiveness and Performance:

- STE Inc I Operational Assessment (OA) #1 4QFY22
- STE Inc I OA #2 3QFY23
- STE Inc I IOC 4QFY23
- Incorporate UK Division in Warfighter Exercise (WFX) 23-4 and increase the Priority Focus Areas that are fully integrated 3QFY23
- Fully Integrate Allied Division in WFX 24-3 and increase the Priority Focus Areas that are fully integrated 3QFY24

Milestones:

Milestone 1: The Synthetic Training Environment (STE) is the integration of three separate training environments into one unified system that allows for distributed collective training from fire team to echelons above corps. The STE Increment One will replace the Army's legacy virtual collective trainers. It will introduce the core of the STE, the STE-Information System (STE-IS), which will serve as the single software that runs all STE training platforms.

Start date: FY23Q1; **End date:** FY27Q4

Milestone 2: Increase rigor and improve interoperability in Warfighter Exercises (WFX) to validate and inform bilateral and multilateral standards

Start date: FY17Q3; **End date:** FY24Q3

Task 4.2.c: Transform Advanced Individual Training (AIT)

OPR: TRADOC CAC; **Data Owner(s):** All branch Centers of Excellence (CoEs) (Aviation, Cyber, Fires, Intelligence, Maneuver Support, Medical, NCO Leader, Sustainment, and Special Operations)

TRADOC through CAC and all branch Centers of Excellence (CoEs) will review AIT POIs and recommend changes to improve efficiency. TRADOC will also determine

Army People Strategy: Military Implementation Plan 2.0

whether Soldiers have maintained the skills they learned in basic training. All AIT courses will identify and implement ways to increase the rigor of the Solidarization process within existing resources and course lengths.

Task End State: Improved branch Advanced Individual Training courses across TRADOC resulting in a more agile, knowledgeable, and skilled MOS trained Soldier ready and capable of serving in Multi-Domain Operationally ready Force. This also includes improved and enhanced, data-centric feedback loops between the Operational Force and branch AITs to ensure the training continually improves to meets the standards and expectations of unit leadership.

Dependencies: This task is accomplished by incorporation into normal operational and maintenance funding or through modernization funding based on branch specific capability development processes.

Task Measures of Effectiveness and Performance:

Measures of Performance:

- All branch AIT POIs inspected and evaluated by TRADOC CAC
- Branch AIT modernization programs reported, codified, and completed
- Development of assessment systems or programs to provide feedback from Fielded Force back to branch AITs
- Continual improvements of systems necessary to incorporate Operational Force feedback, such as POI review processes and Quality Assurance inspections

Measures of Effectiveness:

- Increased Army Senior Leader dialogue on feedbacks and improvements of AITs
- Improved Soldier satisfaction of training received at AIT
- Improved gaining unit satisfaction of Soldiers received from AIT

Milestones:

Milestone 1: Determination of systematic inspections of each branch AIT POIs to assess sufficiency in reinforcement training to reduce degradation of Soldier knowledge and skills. These inspections can be reported through Quality Assurance offices at echelon.

Start Date: FY23Q1; **End Date:** FY25Q4

Milestone 2: Determination and approval of a deliberate assessment to validate newly assigned Soldiers to the Operational Force to ensure retention of MOS Skills. These assessments should not intrude or impact organizations and collect valuable data to improve systemically improve AITs through data centric analysis via no-or-low cost, existing feedback mechanisms.

Start Date: FY25Q1; **End Date:** FY28Q4

Army People Strategy: Military Implementation Plan 2.0

Milestone 3: Determination and approval of a deliberate assessment to validate AIT Soldiers during their qualification of MOS Skills. Collection of branch specific AIT improvement/modernization programs to increase rigor, modernize or improve Soldierization process.

Start Date: FY23Q1; **End Date:** FY25Q4

Objective 4.3: Credential the Army

OPR: TRADOC; **OCR:** DCS G-1

The Army Credentialing Program is a multi-faceted program that provides Soldiers the opportunity to earn professional credentials, including civilian certifications, licenses, and Department of Labor (DOL) Certificates of Completion of Apprenticeship. The program is constantly evolving through the expansion of civilian credentialing opportunities to validate Soldiers' professional skills, training, and work experiences; bolster individual military-technical competence; and improve collective Army readiness. To maximize Soldier civilian credentialing opportunities in all three learning domains (institutional, operational, and self-development), the Army has developed three types of credentialing opportunities: Credentialing Assistance (CA) (Line of Effort (LOE) 1), Institutionally Delivered Credentialing (IDC) (LOE 2), and United Services Military Apprenticeship (USMAP) (LOE 3). IDC and USMAP are no-cost programs to Soldiers. As authorized by Army Regulation 621-5 (Army Continuing Education System), dated 28 October 2019, the Army funds Soldiers through CA.

Within the context of the APS, the objective of Credentialing is to: *Increase the rigor associated with the training and education of Army professionals, aligning credentialing and certification more closely with demonstrated and measurable expertise rather than time in grade, service, or position.*

The Army Credentialing program allows Soldiers to receive training and/or exams that lead to the award of a civilian nationally/industry recognized license, certification, or credential. Some are aligned to their MOSs, while others may not be, but all are intended to provide value to the Army and to potentially support transition into civilian life after service. Ability to follow-up after separation is currently limited and represents a potential area for future improvement.

Objective End State: By implementing the Army Credentialing Program, the Army increases opportunities for Soldiers to pursue credentials while serving through individual study (CA) and Army training schools (IDC). Synchronizing credentialing opportunities throughout the Soldier Life Cycle and adopting high-quality standards for credentials creates agile, adaptive, and innovative Soldiers. The Army Credentialing Program supports the APS strategic outcomes of Ready, Professional, Diverse, and Integrated. Attainment of civilian credentials helps identify talents, creates a more professional force, contributes to knowledge and skills, and increases the nexus between Soldiers and civilians.

Army People Strategy: Military Implementation Plan 2.0

Objective Measures of Effectiveness and Performance:

- Rate at which Soldiers seeking credentials pass credentialing examinations (goal: **increase**) (Source: TRADOC/Army University/CAC)
- Percentage of total student force that participated in the credentialing program (goal: **increase**) (Source: TRADOC/Army University/CAC)
- Percentage of Centers of Excellence participating in the IDC program (goal: **increase**) (Source: TRADOC/Army University/CAC)

Key Tasks:

Task 4.3.a: Increase Soldier Participation in the Army Credentialing Program

OPR: ACCESS ArmyU

In October 2019, all credentialing was realigned under Army Credentialing and Continuing Education Services for Soldiers (ACCESS), Army University. With this merger comes the opportunity to enhance program management and ultimately provide a better credentialing program for Soldiers. This task expands upon existing programs, leverages existing processes and procedures, while attempting to open greater credentialing opportunities in support of the Total Force.

An established and integrated credentialing program results in Soldiers' enhanced capability to serve the nation while in uniform, and a smoother transition to civilian employment when departing the Service. The Army Credentialing Program creates more capable Soldiers to meet the challenges described in the *National Defense Strategy* with increased efforts on a Soldier's personal and professional development through the attainment of civilian technical and professional credentials. A fully established Army Credentialing Program increases Soldiers' military skills and proficiency and enhances self-development and learning in technical areas. Civilian certifications and licenses document a Soldier's knowledge, skills, and behaviors (KSBs) which are included in Talent Management assessments, career coaching, and career alignment.

Task End State: An increased number of Soldiers with documented professional credentials that improve their competencies while serving and prepare them for return to civilian jobs.

Dependencies: None Identified.

Task Measures of Effectiveness and Performance:

- CA participation: 30% of eligible Soldiers (all ranks) participate in voluntary education and/or credentialing.
- Representative Soldier CA participation
- IDC: 75% of MOSs with an aligned credential offer the credential in coordination with Army training.
- Credential preparation training: 95% of Soldiers successfully complete credential preparation training

Army People Strategy: Military Implementation Plan 2.0

- Credentialing exam pass rate: 90% of Soldiers successfully pass credential exam or complete USMAP apprenticeship program.

Milestones:

Milestone 1: Publish the Army Credentialing Strategy.

Start date: FY23Q1; **End date:** FY23Q4

Milestone 2: Develop a model to project participation of Soldiers and required funding.

Start date: FY23Q1; **End date:** FY23Q4

Milestone 3: In coordination with **Task 4.1.b: Collaborate with Academia**, develop a concept plan for the crosswalk of military training to civilian credentialing standards to identify alignment and gaps.

Start date: FY23Q1; **End date:** FY23Q4

Milestone 4: In coordination with **Task 4.1.e: Increase Soldier Success in Voluntary Education Programs**, provide CA input to AR 621-5 and Department of the Army Pamphlet (DA PAM) 621-5 draft updates.

Start date: FY23Q1; **End date:** FY23Q4

Milestone 5: IDC and USMAP added to AR 350-1 and supporting TRADOC regulation.

Start date: FY23Q1; **End date:** FY25Q4

Task 4.3.b: Market the Army Credentialing Program

OPR: ACCESS ArmyU

The Army will market the Army Credentialing Program to inform Soldiers, leaders, and America's youth of civilian credentialing opportunities that afford Soldiers a nontraditional educational opportunity with a focus on technical career fields. Like tuition assistance (TA), credentialing serves as a recruiting and retention tool. Soldiers have the opportunity to earn initial and progressive civilian credentials that align to their military skills and duties, thereby increasing their military-technical competence as well as opportunities to attain civilian credentials not aligned to their military duties. The Army Credentialing Program will produce Veterans with documented technical skills translated into civilian credentials. The more tangible benefit to the Army may be reduction in unemployment benefits paid to the Department of Labor. Potential savings could be reallocated to other Army priorities.

Task End State: Soldiers who have achieved civilian credentials. The Army Credentialing Program develops talent for the Army while simultaneously producing Veterans with the technical skills needed to help close the nation's employment skills gap. Effective marketing of the program will increase recruitment because Soldier attainment of civilian certifications and licenses directly translates military skills and

Army People Strategy: Military Implementation Plan 2.0

duties into civilian careers. Retention will also increase as Soldiers earn stackable credentials through a combination of postsecondary education and credentialing.

Dependencies: None Identified.

Task Measures of Effectiveness and Performance:

- 5% annual increase of program enrollment.

Milestones:

Milestone 1: Update and implement Strategic Communication (STRATCOM) plan in support of the Army Credentialing Program and Soldier for Life (SFL).

Start date: FY23Q1; **End date:** FY25Q4

Task 4.3.c: Develop Automated Solutions to Support the Army Credentialing Program

OPR: ACCESS ArmyU

The Army will develop an automated enterprise system (ArmyIgnitED) to inform Soldiers of credentialing opportunities, facilitate enrollments, ensure audit readiness of credentialing funds, and provide data analytics in support of the credentialing program. The system will provide data vital for program management. The CA system needs to be integrated with the Tuition Assistance (TA) system to provide seamless financial management of CA and TA. The system will develop, implement, and maintain system capability, for both CA and IDC to:

- Facilitate Soldiers' requests for financial assistance for credentialing costs, such as exams, fees, books, and training.
- Establish, track, and restore, in real-time CA limit/balances as a separate funding flow from TA.
- Track enrollment and registration for academic institutions and vendors.
- Manage credentialing funds.
- On-board credentialing vendors from a government-approved source.
- Provide invoicing capability for credentialing payments.
- Track and enforce eligibility rules based upon Army policy.
- Allow vendors to perform credential information management.
- Create processes for up-front payments.

Task End State. An automated enterprise system (ArmyIgnitED) that supports Soldiers' credentialing opportunities and serves as a financial management tool for CA funds, administration of IDC funds and enforces audit readiness.

Dependencies: None Identified.

Task Measures of Effectiveness and Performance:

- Achieve milestones: system milestones achieved on time and budget.
- Resourcing: sufficient funding in Management Decision Packages (MDEP) to support modernization of enterprise systems and interfaces.
- Automation: critical requirements automated and functionality validated.

Army People Strategy: Military Implementation Plan 2.0

- User tracking: ability to track user participation in enterprise system

Milestones:

Milestone 1: CA LOE 1- Fully automate financial and invoicing functionalities in the system.

Start date: FY23Q1; **End date:** FY24Q4

Milestone 2: IDC LOE 2 -Develop and implement Stakeholder capabilities into an enterprise system.

Start date: FY25Q1; **End date:** FY26Q4



**Chapter 5: Employ Talent
Military Implementation Plan 2.0**

Army People Strategy: Military Implementation Plan 2.0

Employ Talent LOE

Lead Integrator: DCS G-1

Introduction: By 2030, the Army will identify, align, and advance the diverse talent needed for the multi-domain force envisioned in the *Army Strategy*. To do this we must maximize the engagement and contribution of Soldiers by aligning their unique talents toward meeting current and future organizational talent demands to the benefit of the Army, the organization, and the individual.



Figure 7: Employ Talent APS Line of Effort

This LOE prioritizes tasks and activities from FY21-FY22 and identifies future implementation efforts necessary to include into the Program Objective Memorandum (POM) cycle in FY23-FY27. The Deputy Chief of Staff (DCS) G-1 serves as the lead integrator for LOE 3. The lead integrator synchronizes supporting tasks necessary to achieve the three objectives and ensures unity of effort with all key stakeholders.

Talent Management is a key concept in the Employ LOE, as well as a critical component of modernizing how the Army employs its personnel.

From Field Manual (FM) 1-0, "Talent management is transformational, increasing organizational agility, focusing on productivity, and manifests as readiness and lethality. It also integrates all people practices, generating a positive effect on organizational outcomes and leveraging each individual's knowledge, skills, behaviors, and preferences (KSB-P) for the mutual benefit of the Army and the individual (based on The Army People Strategy reference).

Talent management extracts the most productivity and value from an organization's greatest asset—its people. Army talent management integrates people acquisition, development, employment, and retention strategies. It begins with entry-level personnel and aligns their talents against the demand for them during their entire careers, to include positions at the very top of the Army. Talent management provides an opportunity for the HR community to dominate the human capital arena if properly executed. Human resources professionals should be experts in talent management initiatives and processes."

Army People Strategy: Military Implementation Plan 2.0

Figure 8: Employ Talent LOE Strategic Outcomes

The Army will implement the Employ Talent Line of Effort by achieving these six strategic outcomes:

1. The Army inculcates a culture of assessment
2. The Army capitalizes on granular personnel details in career field alignment
3. The Army aligns the right Soldier to the right place at the right time
4. The Army improves Soldiers' understanding of themselves and their options
5. The Army advances those who are ready today to serve in positions of increased responsibility
6. The Army exploits opportunities to create more flexible career paths

Employ Talent LOE End State: Through the Employ Talent LOE, the Army can align and employ talent toward meeting the Army 2030 vision outlined by the *Army People Strategy* and updated through 2030 by the *Army Strategy*.

Objective 5.1: Identify Talent

OPR: DCS G-1; **OCR:** HRC

According to the APS, to Identify is to: *Leverage technology and comprehensive assessments to assess individual knowledge, skills, and behaviors to maximize human potential and output.*

More directly, the objective is to identify the talents and preferences within the workforce. Historically, personnel management has been primarily a matter of rank or grade and MOS or branch checked against the needs of the Army. By codifying the knowledge, skills, behaviors, and preferences of Soldiers, including those they may not have any formal military training or education in, we can better understand the human resources available to the Army. This is a foundational component of modernizing how the Army modernizes its talent management processes. Though KSBs are typically self-professed, the Army must increase its ability to formally assess its Soldiers to validate these assertions, as well as to identify talents Soldiers may not even know they have. This increased emphasis on assessment is in alignment with the second objective in the SECARMY's February 2022 Message to the Force.

Objective Measures of Effectiveness and Performance:

- Percent of Soldiers in the Talent Marketplace (ATAP, ASK-EM) listing KSB-Ps in their profiles (goal: **increase**) (Source: HRC)
- Percent of units in the Talent Marketplace (ATAP, ASK-EM) using KSB-Ps in their job announcements (goal: **increase**) (Source: HRC)
- Percentage of eligible Soldiers who have taken Athena assessments (goal: **increase**) (Source: TRADOC CAC)
- Percent change to the final command and key billet Order of Merit List (OML) between the Centralized Selection List (CSL) and after candidates are assessed through CAP (Source: Army Talent Management Task Force)

Army People Strategy: Military Implementation Plan 2.0

- Percentage of Talents that have at least one KSB formally assessed (goal: **increase**) (Source: ATMTF)

Key Tasks:

Task 5.1.a: Command Assessment Program (CAP)

OPR: ATMTF; **OCR:** TRADOC; **Data Owner:** Command Assessment Program

The Command Assessment Program (CAP) is the Army's way of assessing and selecting leaders for its most critical command and key billet assignments. Augmenting the select legacy, board-only, selection processes, the CAP assesses the whole person, informing principal officials that leaders recommended for these critical positions have the Knowledge, Skills, and Behaviors required to win in a multi-domain environment.

In the future, the Command Assessment Program will generate validated command and key-billet selection lists for the FY25-27 Army Competitive Category and select additional policy boards. The Command Assessment Program will fill newly active TDA positions and be stationed at its permanent location. CAP will serve as the culminating objective assessment model that synchronizes developmental career assessments, data science applications, longitudinal analysis frameworks, policy, and doctrine for Army leader development.

Task End State: By 1st quarter FY25, CAP is fully integrated within the Army's synchronized leader selection processes and policies.

Dependencies: Continuing CAP through FY23-25 is contingent on a partial Directed Military Overstrength (DMO) extension through FY24 and full authorized TDA and stationing decision no later than 3rd quarter FY22. When approved, IOC is feasible by 1st quarter FY25 and FOC 4th quarter FY25.

Task Measures of Effectiveness and Performance:

Measures of Performance:

- Percentage of candidates determined Ready/Not Yet Ready for Command
- Percentage of the final CSL list that changed because of CAP compared to board-only CSL
- Difference in the assessed physical, cognitive, written, and verbal performance between CAP selectee's vs CSL.

Measures of Effectiveness:

- CAP data and determined subsidiary variables based off leader performance and influence in assigned billets are used to assess and redefine leader selection and development processes across the Army.
- MOEs are determined via milestone 6. Studies are ongoing as we determine long term outcomes of CAP.

Milestones:

Army People Strategy: Military Implementation Plan 2.0

Milestone 1: Execute O-5 Army Competitive Category (ACC) CSL [BCAP], O-5/GS-14 Acquisition Corps (ALAP), and Division Chaplain (DCHAP) assessment and selection program for the FY25-27 CSL and selection boards.

Start date: FY23Q1; **End date:** FY25Q4

Milestone 2: Execute O-6 ACC CSL (CCAP), O-6/GS-15 Acquisition Corps (ALAP), O-6 Medical Corps (MCAP), and O-6 Chaplain (CCHAP) assessment and selection program for the FY25-27 CSL and selection boards.

Start date: FY23Q1; **End date:** FY25Q4

Milestone 3: Execute the Sergeant Major Assessment Program (SMAP) for the FY 25-27 billets.

Start date: FY23Q1; **End date:** FY25Q4

Milestone 4: Prototype, if feasible, additional populations for assessment in the CAP when requested by proponent principals and directed by Army Senior Leaders.

Start date: FY23Q1; **End date:** FY25Q4

Milestone 5: Transition the CAP to a permanent structure and integrate the CAP into Army policy as a requirement for CSL. Establish stakeholder relationships across the Human Capital Enterprise to coordinate the execution of the CAP in accordance with Army requirements. Define resource requirements for CAP and Talent Management, aligned with the POM cycle.

Start date: FY23Q1; **End date:** FY25Q4

Milestone 6: Design research framework for CAP longitudinal data studies of the efficacies of the CAPs MOPs/MOEs based off data regressions and analytics of current CAP populations to define CAPs Measures of Effectiveness.

Start date: FY22Q2; **End date:** FY25Q4

Milestone 7: Sustain the Army Enterprise Assessment Program (AEAP) and its supporting IT backbone (AEAS) as a key enabler to support the Command Assessment Program and promote a culture of assessments across the Army

Start date: FY23Q1; **End date:** FY25Q4

Task 5.1.b: Talent Assessments Strategy (TAS)

OPR: TRADOC; **OCR(s):** ATMTF, ARI, ArmyU, TRADOC CAC, & HRC; **Data Owner(s):** ASA(M&RA), DCS G-1, HRC

The TAS is a foundational document which will guide the development of a sustainable ecosystem of assessments that takes place during a Soldier's career. The TAS will identify the critical time periods and situations in which assessments will be required or available through a Soldier's career to track professional growth and development,

Army People Strategy: Military Implementation Plan 2.0

make critical career decisions, or assist individuals in moving forward in their chosen career paths. The TAS will encompass existing assessments across the officer, warrant officer, and enlisted cohorts, including accessions and initial entry screening, major developmental assessments, and critical leadership gateway assessments like the Command Assessment Program (CAP). The TAS will guide the creation and use of additional assessments by highlighting both the current assessments in use or development as well as gaps that are not yet addressed. It will also inform where and when predictive, diagnostic, or developmental assessments are required for each of the gaps.

Task End State: The assessment strategy drives the creation and maintenance of talent assessments supporting the twenty-first century Talent Management System and informs resource prioritization to ensure a robust and effective assessment ecosystem is maintained. Assessments throughout the ecosystem are valid and meaningful indicators of talent strengths and gaps for Soldier development and Army personnel decisions across the lifecycle.

Dependencies:

- Appropriate resources to support development, maintenance, and analysis of assessments
- Assessments alignment with the Army Talent Attributes Framework (ATAF)
- Approved/Recommended Talent Assessment structure from initial entry through senior grade assignment

Task Measures of Effectiveness and Performance:

Measures of Performance:

- Army Assessments Strategy draft produced no later than 31 JUL 22
- Army Assessments Strategy reviewed no later than 30 NOV 22
- Army Assessment Strategy approved no later than 31 JAN 23
- Army Assessment Strategy published no later than 31 MAR 23

Measures of effectiveness:

- Number of developmental assessments for Enlisted Service Members & Officers
- Number of diagnostic assessments for Enlisted Service Members and Officers
- Number of predictive assessments for Enlisted Service Members and Officers
- Number or percentage of assessments aligned under ATAF

Milestones:

Milestone 1: Publish Talent Assessments Strategy (TAS)

Start date: FY22Q2; **End date:** FY23Q2

Task 5.1.c: First Sergeant Talent Alignment Assessment (TAA) [Previously known as: Senior Noncommissioned Officer Assessment Program (SNAP)]

OPR: ATMTF; **Data Owner:** ATMTF, DCS G-1, HRC EPMD

Army People Strategy: Military Implementation Plan 2.0

The First Sergeant Talent Alignment Assessment (1SG TAA) is an assessment program designed to gain insights on senior NCOs to better align the talents of individuals to meet specific positions and inform senior NCO slating decisions. The assessment process must provide relevant information on the demand (positions available and specific details on talent required to fill them) as well as the physical, cognitive, temperamental, technical, and tactical talents of eligible NCOs to fill the positions. This assessment will occur at the division level in a decentralized manner with data being stored in the Personnel Data Environment (PDE).

Task End State: Companies, troops, and batteries consistently receive NCOs whose unique talents best align with the unit's needs at the time. Talent alignment raises readiness levels and retention of Soldiers in each unit. Stability and assignment predictability increases for NCOs and their families.

Dependencies: Continuing 1SG TAA through FY23-25 is contingent on continued Army Research Institute (ARI) research support efforts for data collection and analysis through multiple assessments. Data storage and access to 1SG TAA outcomes are dependent on the implementation of IPPS-A Release 3 and future versions. The implementation of the market in FY 23, enabled by the Enlisted Army Talent Alignment Process (EATAP), will streamline the access and availability of open 1SG billets and qualified applicants.

Task Measures of Effectiveness and Performance:

- Difference in scores across physical fitness, past performance, and cognitive/non-cognitive assessment between the pre-TAA slating population and the post-TAA slated NCOs.
- Contrast HR metrics in units led by a TAA slated NCO with units led by a conventionally slated First Sergeant.
- Contrast quantifiable metrics: EIB/EFMB/ESB rates, weapons qualification scores, school graduation rates, special award recipient rates, etc.
- Contrast DACES (or a modified command climate survey) results in units with a TAA slated NCO versus a unit led by a conventionally slated First Sergeant.

Milestones:

Milestone 1: Conduct second pilot with U.S. Army Pacific (25ID and 8TSC) theater level unit in FY22 Q4

Start date: FY22Q2; **End date:** FY22Q4

Milestone 2: Conduct first pilot with U.S. Army 3rd Corps and Fort Hood assigned units in FY 23 Q1

Start date: FY22Q2; **End date:** FY23Q1

Milestone 3: Conduct first pilot with U.S. Army Europe theater level units in FY 23 Q2

Start date: FY22Q4; **End date:** FY24Q1

Army People Strategy: Military Implementation Plan 2.0

Milestone 4: Conduct 2nd pilot with U.S. Army 18th Airborne Corps units and begin transition with TRADOC and the Noncommissioned Officer Leadership Center of Excellence (NCOLCoE) FY23 Q3

Start date: FY23Q2; **End date:** FY24Q1

Milestone 5: Conduct 1st pilot with U.S. Army First Corps theater level units in FY23 Q4

Start date: FY23Q3; **End date:** FY24Q2

Milestone 6: Transition 1SG TAA to TRADOC and NCOLCoE in FY24 Q2

Start date: FY23Q1; **End date:** FY24Q2

Task 5.1.d: Army Talent Attribute Framework

OPR: ATMTF; **Data Owner:** DCS G-1

The Army Talent Attribute Framework (ATAF) provides a synchronized lexicon for using talent and Knowledge, Skill, and Behavior (KSB) information in twenty-first century talent management. ATAF is a three-tiered framework for expressing talent attributes using broad Talent Domains, subcategories known as Talents, and measurable Knowledge, Skills, and Behaviors. The ATAF unifies the definitions and concepts for talent, which previously existed across multiple Army programs, initiatives, documents, policies, doctrine, and professional military education courses. The ATAF develops a common picture for understanding talent attributes for individuals within Army talent management systems, enables Army leaders to recognize talent gaps across the Army and within specific markets, and provides a data layer for more deliberate career mapping by individuals and succession planning by units and Army leadership.

ATAF enables establishment of a common data layer of individuals' KSBs across the career lifecycle and throughout the force. Its MOPs and MOEs reflect its suitability in accurately describing, enabling standardized measurement of, and tracking data on the talent attributes in support of the performance requirements of current and future doctrine and concepts.

Task End state: Establish ATAF as the common language for describing, measuring, and recording talents for the Army; KSBs serve as data layer for data-rich talent management. ATAF policy governance codified at M&RA; ATAF policy generation at Directorate of Military Personnel Management (DCS G-1 DMPM); ATAF implementation with DCS G-1 (APS LOEs Employ & Retain), TRADOC (APS LOEs Acquire & Develop), DCS G-3 (Force Management).

Dependencies: Publication of the ATAF Army Directive, the Talent Assessment Data Usage Army Directive, Release of IPPS-A Release(s) 4.X+.

Task Measures of Effectiveness and Performance:

Measures of Performance:

Army People Strategy: Military Implementation Plan 2.0

- ATAF revalidated and aligned to Army MDO requirements on an annual or biennial basis by 2Q of FY
- Branch Proponent/Functional Area expected KSBs for members by AOC/MOS, grade, and for select duty positions updated, published through TRADOC CAC, and distributed to members annually Army Regulations (e.g., AR 600-3, AR 71-32) updated within two years of publication of Army Directive
- Human Resource and Force Management data systems incorporate ATAF data requirements, as appropriate, within two years of publication of Army Directive
- All KSBs of currently approved ATAF available for use by officers/warrant officers/NCOs
- All KSBs of currently approved ATAF available for use by units during Mission Essential Requirements submission period
- Units and individuals searchable by KSBs during marketplace

Measures of Effectiveness:

- Number of Human Resource and Force Management systems that express talent requirements through ATAF
- Number of Army Regulations and associated Publications that express talent requirements through ATAF
- Culture of Army assessments established using the common language of ATAF
- 100% of 25-point talent profiles contain KSBs
- 100% of duty positions list associated KSBs

Milestones:

Milestone 1: Army Talent Attribute Framework (ATAF) codified within Army policy.

Start date: FY22Q3; **End date:** FY24Q4

Milestone 2: Talent data access and usage policy in place.

Start date: FY22Q3; **End date:** FY24Q4

Milestone 3: IPPS-A develops strategy to incorporate ATAF annual review data into 25-point talent profile.

Start date: FY22Q3; **End date:** FY24Q4

Objective 5.2: Align Talent

OPR: DCS G-1; **OCR:** Office of Economic and Manpower Analysis (OEMA)

According to the APS, to Align is to: Provide Soldiers and Civilians with positions that unleash their passions and talents, maximizing performance and productivity in both the operating and generating forces; create dynamic feedback mechanisms to measure the effectiveness of talent alignment efforts; identify Soldier and Civilian talent gaps; and refine Army developmental programs to close those gaps.

Alignment is a critical process within the Army People Enterprise. Historically, this has mainly been assessed as a percent of fill of critical positions and MOSs. As the Army's

Army People Strategy: Military Implementation Plan 2.0

Talent Management capabilities mature, we will be able to better align specific talents with specific positions. Eventually, we will be able to predict how well individuals will perform within given positions and align with that in mind. Although this capability is still maturing, the underlying infrastructure and processes to match people with positions has come to a point where we can begin aligning Soldiers and assessing those matches, at least within specific programs. One of the critical requirements to develop this capability is more thorough, objective, force-wide performance assessment so we can quantify the benefits to the Army of proper alignment. Using data to help drive assignment and alignment is in keeping with the second objective in the SECARMY's February 2022 Message to the Force.

Objective Measures of Effectiveness and Performance:

- Percent of fill of critical positions and MOSs (goal: **increase**) (*Source: DCS G-1 DMPM*)
- Percent of Cadets assigned to Branches with a "Least Preferred" designation out of total Soldiers Branched through Talent Based Branching (goal: **decrease**) (*Source: OEMA*)
- Percent of Cadets receiving one of their top 3 Branch preferences out of total Soldiers Branched through Talent Based Branching (goal: **increase**) (*Source: OEMA*)
- Percentage out of all respondents of Soldiers indicating "Opportunities to use my skills and abilities" is a reason to stay (goal: **increase "Reason to STAY" responses on DACES**) (*Source: ATMTF*)

Key Tasks:

Task 5.2.a: Talent Based Branching (TBB)

OPR: DCS G-1 DMPM; **OCR(s):** ATMTF, TRADOC; **Data Owner:** OEMA

Task End State: Cadet talents aligned with branch requirements to increase the lethality of the Army and the professional satisfaction of officers.

Dependencies: None Identified.

Task Measures of Effectiveness and Performance:

- Percentage of cadets assigned as Most Preferred, Preferred, and Least Preferred.
- Cadet preference achievement
- Gender and Race and Ethnic Designation Category (REDCAT) diversity across all branches
- Percentage of cadets possessing desired Domain Specific Education assigned in CY, EN, and FC
- Relationship between TBB measures of fit (talent scores, branch ratings) for cadets with signals of high performance as junior officers (e.g., selection for challenging assignments such as Aide-de-Camp, Scout PL, or SOF).

Army People Strategy: Military Implementation Plan 2.0

- Relationship between TBB measures of fit (talent scores, branch ratings) for cadets with signals of satisfaction as junior officers (e.g., likely from surveys).
- Relationship between TBB measures of fit (talent scores, branch ratings) for cadets with junior officer continuation in the branch and/or the Army.

Milestones:

Milestone 1: All branches collect, aggregate, store, and share BOLC performance data with DCS G-1 for analysis and program evaluation.

Start date: FY22Q3; **End date:** FY23Q3

Milestone 2: USACC/USMA execute FY23 branching board.

Start date: FY23Q1; **End date:** FY23Q2

Milestone 3: DCS G-1 conducts pilot and/or simulation of a combined USMA/USACC branching market.

Start date: FY23Q1; **End date:** FY23Q2

Milestone 4: DCS G-1 collaborates with TRADOC and HRC to analyze the impact of TBB on junior officer performance, satisfaction, and continuation.

Start date: FY23Q2; **End date:** FY25Q2

Task 5.2.b: Army Talent Alignment Process (ATAP)

OPR: ATMTF; **Data Owner:** HRC, PA-CFG

Task End State: ATAP's market mechanism will provide the Army with real-time information on its talent supply and demand because it incentivizes individuals and units to provide their talent information. This talent information can then be used to help shape personnel policy, forecast aspects of personnel readiness, allocate resources, and conduct workforce planning. The long-term vision of ATAP is that it serves as a critical talent data collection tool within People Analytics.

Dependencies: Full market functionality depends on the roll-out of IPPS-A Release 3.X (targeted for late FY22)

HRC must bring Total Officer Personnel Management Information System (TOPMIS) 2 data into compliance with the Army's Data Omnibus (AD 2021-18)

Task Measures of Effectiveness and Performance:

Measures of Performance:

- Recommendation engine present in IPPS-A
- Training on recommendation engine included in HRC's marketplace education
- Twice annually ATMTF hosts a series of meetings on ATAP governance
- KSBs incorporated into Policy & Doctrine. KSBs used consistently (e.g., >85% of users use KSBs, average number of KSBs per user > 5)

Army People Strategy: Military Implementation Plan 2.0

Measures of Effectiveness:

- In the post-market survey, ask units to what extent they used the recommendation engine to shape their interview slate
- Percentage of changes made that support market principles (thick, fast, transparent, and safe)
- Percentage of jobs competed in the market by branch/FA
- Percentage of assignments filled by the market in each distribution cycle
- Yes/No: changes to Army Talent Alignment Algorithm (ATAA) are consistent with deferred-acceptance algorithms.
- In the post-market survey, ask movers to what extent they researched units based on the recommendation engine
- Number of matching (unit & mover) KSBs trends upward

Milestones:

Milestone 1: Begin full implementation off KSBs in the marketplace

ATAP market functionality is included in IPPS-A Release 3.X. The TM Release was delayed approximately one year. During this time ATAF has made an extensive push to educate the force on the language of talent (e.g., KSBs) and will continue to push information on what they can do for individuals and units.

Start date: FY22Q1; **End date:** FY24Q4

Milestone 2: ATMTF in coordination with People Analytics Cross Functional Group (PA-CFG) (M&RA) executes programmatic study of ATAP

A programmatic study of ATAP is being conducted by ATMTF. They review the market parameters and staff possible improvements through a council of colonels, HCE leaders, the DCS G-1, and – when necessary – the VCSA.

Start date: FY23Q1; **End date:** FY25Q4

Milestone 3: Develop a recommendation engine for AIM2.0 to increase unit/individual matches based on KSB alignment (designed to integrate with IPPS-A Release 3)”

Start date: FY23Q1; **End date:** FY23Q4

Task 5.2.c: Talent Based Career Alignment

OPR: HRC; **Data Owner:** HRC

Retain high performing officers into their field grade years by guaranteeing them an assured mid-career pathway from Captain’s Career Course (CCC) to Intermediate Level Education (ILE).

Task End State: Talent Based Career Alignment (TBCA) serves as a junior officer retention tool. TBCA seeks to retain high performing CPTs with war winning talent by providing them and opportunity to apply for an “Assured Mid-Career Pathway” while attending the CCC. If selected, these officers will have 5-7 years of career predictability.

Army People Strategy: Military Implementation Plan 2.0

Dependencies: With full implementation at all CCCs, HRC must collect and analyze data for all TBCA selectees. HRC must determine the rate at which TBCA selectees are being retained against the general population of officers in respective year groups. There are several efficiencies to be gained (i.e., systems available for officer tracking, availability of personnel to inform of TBCA).

Task Measures of Effectiveness and Performance:

Measures of Performance:

- Total number of AMCPs participating

Measures of Effectiveness:

- Percentage of officers selected for AMCPs using TBCA vs traditional means
- Percentage of TBCA selectees who reported to and executed their AMCP
- Percentage of TBCA selectees' promotion rate to Major
- Percentage of TBCA selectees who attend ILE
- Percentage of TBCA selectees who continue service after ILE into their field grade years

Milestones:

Milestone 1: Begin full implementation of TBCA at all CCCs.

Start date: FY23Q1; **End date:** FY23Q3

Milestone 2: TBCA refined systems and processes while adding additional Assured Mid-Career Pathways (AMCPs) to the program.

Start date: FY23Q1; **End date:** FY26Q2

Task 5.2.d: Army Coaching Program

OPR: ATMTF; **Data Owner:** ATMTF, DCS G-1

The Army Coaching Program (ACP) implements a non-attributional and confidential sounding board that concentrates on enhancing career development, professional goals, self-awareness, and potential. The program provides credentialed and certified coaches assisting Service Members with making more informed career decisions with respect to their KSBs through development of goals and interpretation of assessments.

Task End State: By 2nd quarter of FY23, the Army Coaching Program is fully implemented with the publication of an Army Directive and Army Regulation.

Dependencies: Continuing the ACP is contingent on the publication of the ACP Army Directive and ACP Army Regulation; a functional proponent to manage and approve PDSIs; implementation and monitoring external coaching contracts and internal training contracts.

Army People Strategy: Military Implementation Plan 2.0

Task Measures of Effectiveness and Performance:

- Increased availability of certified Army coaches to accommodate and support Service Members registered in ACP
- Improvements in accreditation level and expertise of Army coaches utilizing the foundations and principles of International Coaching Federation (ICF)
- Encouraging experience and assessment improvements by Service Members after coaching
- Positive growth of Service Member's potential to achieve their goals and contribute more effectively to their teams
- Increased retention of Service Members that supports the Army mission
- Positive satisfaction measure by qualitative surveys of Service Members following interaction with coaches

Milestones:

Milestone 1: Army Directive Submitted for Staffing

Start date: FY22Q3; **End date:** FY22Q4

Milestone 2: Army Regulation Submitted for Staffing

Start date: FY22Q4; **End date:** FY23Q1

Milestone 3: Full Implementation of ACP

Start date: FY23Q1; **End date:** FY23Q4

Objective 5.3: Advance Talent

OPR: DCS G-1; **OCR:** HRC

According to the APS, to Advance is to: *Create talent-focused individual career paths for every member of the Army team. Select Soldiers and Civilians for new or specialized work based upon their demonstrated and assessed talents, regardless of pay grade or time in service. Adjust their compensation accordingly.*

Promotion is at the core of the Advance Objective, although assignment to desirable positions and schools may also be part of it. Toward that end, it is key that the Army provide some flexibility and choice to Soldiers in how their careers progress and whether they feel prepared for promotion. Not only does this help us to employ the talents we have within the force, it may also help us retain top performers.

Objective Measures of Effectiveness and Performance:

- Percentage of brevetable positions filled by breveted Soldiers (*Source: HRC*)
- Percentage of captains who accept a Talent Based Career Alignment out of those who are offered TBCA (*Source: HRC ORD*)
- Percentage of those who are selected for promotion out of those who opt in (goal: **increase**) (*Source: HRC ORD*)

Army People Strategy: Military Implementation Plan 2.0

- Percentage of those who accept the Career Intermission Program out of those who apply (*Source: HRC*)
- Percentage of Soldiers in any movement cycle who retire in lieu of reassignment (goal: **decrease**) (*Source: HRC*)

Key Tasks:

Task 5.3.a: Brevet Promotion

OPR: DCS G-1 DMPM; **Data Owner:** DCS G-1 DMPM

Implements changes to Title 10 USC §605 which allow a junior grade officer to be Temporarily Appointed to a higher grade. There are three conditions that must be met. First, that the Officer has a skill in which the service has a critical shortage of personnel as determined by the Secretary. Second, that the officer has been assigned to a position designated critical by the Secretary. Third, that a board of officers recommends the Junior Officer for Temporary Promotion, and they are confirmed through the Scroll process.

This authority moves the Army toward realization of Talent Based Promotion and Pay, allowing commanders to select junior officers with critical skills and upon approval of a General Officer Panel, OSD and the Senate obtain Temporary Promotion and Pay.

Task End State: Brevet is a Commander's Tool to alleviate critical shortages and temporarily promote officers with the right skills and talent into positions that have been validated by the Secretary of the Army as being critical. This authority allows the Army to benefit from the use of a talent-based promotion system.

Dependencies: Approval of Study

Task Measures of Effectiveness and Performance:

- Promotion board analysis to determine if officers accepted for brevet promotions (MAJ through COL) compete at a higher, lower, or at the same rate as their peer cohort groups
- Increased Temporary Promotions compared to Critical Billets Approved

Milestones:

Milestone 1: Office of Economic and Manpower Analysis (OEMA) conduct formal study on designated Branch / Functional Area population

Start date: FY23Q1; **End date:** FY24Q4

Milestone 2: Review and brief results of OEMA Study to ASL

Start date: FY25Q1; **End date:** FY25Q1

Task 5.3.b: Opt-In to a Promotion Selection Board

OPR: DCS G-1 DMPM; **OCR:** HRC; **Data Owner:** HRC

Army People Strategy: Military Implementation Plan 2.0

Allow promotion consideration based on achievement of milestones, create flexibility in timelines, force officer engagement.

Task End State: Engaged officer corps that is recognized by promotion based on accomplishment of milestones, not merely time in grade.

Dependencies: Assignment of an officer as Program Manager (scheduled to arrive on orders summer 22). HRC TDA authorization for civilian Program Manager (1 person total for opt in & opt out).

Task Measures of Effectiveness and Performance:

- Number of officers opting in by branch (even distribution is probably best)
When BZ cohort includes two year groups, Number by branch of those selected so early
- Number of HRC civilian employees with opt in / opt out as primary responsibility

Milestones:

Milestone 1: Write explanatory paragraph into Department of the Army Pamphlet (DA PAM) 600-3 (DCS G-1 DMPM)

Start date: FY23Q1; **End date:** FY25Q4

Milestone 2: Transition process to HRC (HRC)

Start date: FY23Q1; **End date:** FY23Q4

Task 5.3.c: Opt-Out of a Promotion Selection Board

OPR: DCS G-1 DMPM; **OCR:** ATMTF; **Data Owner:** HRC

Create flexibility in timelines to allow officers to participate in developmental opportunities.

Task End State: Engaged officer corps that is better able to participate in developmental opportunities.

Dependencies: Assignment of an officer as Program Manager (scheduled to arrive on orders summer 22). HRC TDA authorization for civilian Program Manager (1 person total for opt in & opt out).

Task Measures of Effectiveness and Performance:

- Number of officers who opted out of a board, who are subsequently selected the following year(s) for promotion [More is better] (measured by HRC)
- Number of officers opting out per board by reason (in ACS, Sig Position, Delayed Career Progression Assignment) (measured by HRC)
- Number of HRC civilian employees with opt in / opt out as primary responsibility (measured by HRC)

Milestones:

Milestone 1: Ensure data points are in AIM2 & IPPS-A

Army People Strategy: Military Implementation Plan 2.0

Start date: FY22Q1; **End date:** FY25Q4

Milestone 2: Transition process to HRC

Start date: FY23Q1; **End date:** FY23Q4

Task 5.3.d: Warrant Officer Competitive Category Expansion

OPR: DCS G-1 DMPM; **OCR:** ATMTF; **Data Owner:** DCS G-1 DMPM

Expand the current two category promotion selection board to nine categories representing the nine respective Army Centers of Excellence with warrant officer populations. Supports ownership of specific requirements such as skills, experience, and time-in-grade eligibility.

Task End State: Provides precision talent management, improving readiness through precise selection of the right people with the right talent at the right time.

Dependencies: Approval of study. Currently in ATMTF FY23 POM.

Task Measures of Effectiveness and Performance:

Measures of Performance:

- Precision promotion of talent and skills to meet critical requirements

Measures of Effectiveness:

- Increased retention of warrant officers in the rank of CW3 and CW4

Milestones:

Milestone 1: FY22 Develop study proposal and identify research agency.

Start date: FY22Q3; **End date:** FY22Q4

Milestone 2: Conduct formal study.

Start date: FY23Q1; **End date:** FY24Q4

Milestone 3: Review and brief results of WO Study to ASL.

Start date: FY25Q1; **End date:** FY25Q1

Milestone 4: Implement changes with FY24 WO promotion board.

Start date: FY25Q2; **End date:** FY26Q1



**Chapter 6: Retain Talent
Military Implementation Plan 2.0**

Army People Strategy: Military Implementation Plan 2.0

Retain Talent LOE

Lead Integrator: DCS G-1

Introduction: By 2030, the Army will engage, compensate, and transition the talent needed for the multi-domain force envisioned in the *Army Strategy*. To do this, we must identify and retain individuals with in-demand talents by engaging them with a mix of compensation and opportunities, including migration across Army workforce positions (permeability). For those choosing to depart the Army, we must transition them in a way that reinforces a powerful and enduring identity as lifelong members of the Army team.

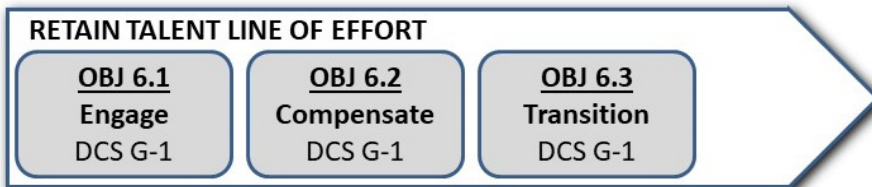

Figure 9: Retain Talent APS Line of Effort

The Army's Mission is unchanged – to deploy, fight, and win the nation's wars. The Army is in a period of reform, modernizing and reforming its materiel solutions and organizations to maintain its competitive advantage in a rapidly changing operational environment. Because war is an inherently human endeavor, the Army must also modernize how it retains its Soldiers and leaders.

Establishing career-long leader mentorship and developmental milestones, creating monetary and non-monetary compensation packages, and increasing permeability between components to leverage and retain talent with the knowledge, skills, and behaviors are critical to maintaining the readiness and lethality of the Army.

Figure 10: Retain Talent LOE Strategic Outcomes

The Army will implement the Retain Talent Line of Effort by achieving these six strategic outcomes:

1. The Army reinforces counseling, mentoring, and coaching as professional responsibilities
2. The Army understands why Soldiers decide to remain in or depart from the Army
3. The Army modernizes its modeling and personnel analytics
4. The Army retains in-demand talent among its Junior Officers
5. The Army maximizes permeability as a tool for retaining talent in the Total Force
6. The Army harnesses the experience of Veterans and Retirees

The Deputy Chief of Staff (DCS) G-1 serves as the lead integrator for LOE 4. The lead integrator synchronizes supporting tasks necessary to achieve the three objectives and ensures unity of effort with all key stakeholders.

Army People Strategy: Military Implementation Plan 2.0

Retain Talent LOE End State: The end state for the Retain Talent LOE is a more productive Army due to the effective retention of knowledge, skills, and behaviors across all components that create a cohesive Total Force.

Objective 6.1: Engage Talent

OPR: DCS G-1; **OCR:** HRC

Army leaders at all echelons are responsible for providing purpose, motivation, and direction to accomplish the mission and improve the organization. This innate responsibility is critical to building cohesive teams, developing talent, and maximizing productivity. Leaders must actively invest in the personal and professional development of their personnel through authentic engagements that focus on the key attributes we strive to develop in the Army. We must strive to instill a sense of self-worth and competitive drive for professional development that is mutually beneficial to the Soldier as well as the Army.

To support and monitor Soldiers' development, leaders must provide continual evaluation of an individual's knowledge, skills, and behaviors that are fundamental to supporting the Army Strategy and actively seek to retain Soldiers. These assessments should align with other career and development programs such as Professional Military Education (PME). By incorporating specific professional growth counseling milestones, renewing efforts on mentorship and retention counseling, and updating Army exit interviews, leaders can gain insight into the challenges faced with retaining talent within the Army and effect strategic change.

The APS has this to say about the Objective Engage: *Authentic leader engagement is critical to developing cohesive teams and maximizing performance. Counseling demonstrates the leader's investment in the development of a subordinate. Ensure formal career counseling to each Army professional at key crossroads in his or her career.*

Career counseling in the Army is seen as a key element of retention—if Soldiers believe their leadership cares about their careers, and that those careers are important to the Army, they are expected to perform better and to stay longer. However, there are significant hurdles in providing access to such to all Soldiers, at all ranks, echelons, MOSs, and duty stations. Many Soldiers may only receive formal counseling for event or performance problems, or when departing the service, and such counseling is usually not focused explicitly on the Soldier's career options. Additionally, data on counseling is limited, partially due to concerns of privacy and partially due to the informal nature of many of the most impactful leader engagements upon junior Soldiers. Mentorship and possibly also the coaching program may also impact outcomes in this space. There are also significant differences in how counseling is handled and recorded between the enlisted and commissioned ranks.

Objective Measures of Effectiveness and Performance:

Army People Strategy: Military Implementation Plan 2.0

- Percentage of those who separate who had a counseling statement in their file within the 12 months prior to separation (*Source: HRC*)
- Percentage of Soldiers receiving developmental counseling in each rating period (goal: **increase**) (*Source: HRC*)
- Percentage out of all respondents of Soldiers indicating that “The mentorship I receive from my unit or organization leadership” is a reason to stay (goal: **increase** “Reason to STAY” responses on DACES) (*Source: ATMTF*)

Key Tasks:

Task 6.1.a: Department of the Army Career Engagement Survey (DACES)

OPR: DCS G-1 DMPM; **Data Owner:** DCS G-1

DACES measures retention intentions and can compare that to actual behavior. DACES informs Army retention policy.

Task End State: DACES continues as a valuable tool to measure retention intentions of Service Members and inform senior leader decision making. Many of the milestones listed in the MIP are complete and no longer relevant. DACES, however, is still relevant and should be a component of the updated APS MIP.

Dependencies: Remains in POM for Research Facilitation Lab financing.

Task Measures of Effectiveness and Performance:

Measures of Performance:

- Maintain greater than 10% participation rate

Measures of Effectiveness:

- Scorecard or criteria for assessment

Milestones:

Milestone 1: OPR continue to send DACES to all active-duty SMs annually during their birth month. Publish an annual report covering findings, methodology, and other relevant information.

Start date: FY20Q3; **End date:** FY23Q1

Milestone 2: Develop criteria for assessment of data and instrument effectiveness; Conduct semiannual review of data and instrument effectiveness with the Research Facilitation Laboratory and Army Research Institute.

Start date: FY22Q4; **End date:** FY23Q1

Task 6.1.b: Retention Prediction Model-Army

OPR: Army People Analytics Office (APAO); **Data Owner:** APAO

Army People Strategy: Military Implementation Plan 2.0

Retention Prediction Model-Army (RPM-A) is an instance of an Office of the Under Secretary of Defense for Personnel and Readiness (OUSD) P&R)) directed tool specifically focused on forecasting retention likelihoods using Army personnel data from aggregate down to the individual level.

Task End State: The Army uses machine learning capable of better understanding individual attrition behaviors of its People. With this granular data, the Army can better identify individuals it desires to retain using scientifically proven and statistically validated intervention strategies.

Dependencies: Requirements for Institute for Defense Analysis and Research Facilitation Lab financing are validated by Program Evaluation Groups (PEG) and funded in the Budget Enactment.

Task Measures of Effectiveness and Performance:

Measures of Performance:

- Definitive valuation of the impact of different incentives

Measures of Effectiveness:

- Impact of offering each of the list of incentives by comparing outcomes among Soldiers in the treatment group to outcomes in the control group.
- Compare the relative impact of the items on the list of Incentives.
- How individuals in the treatment group respond to the incentives.
- Longer-term assessments will examine retention and performance patterns of individuals in the treatment and control group.

Milestones:

Milestone 1: Initiate controlled trial on retention interventions; RPM-A limited pilot.

Start date: FY23Q1; **End date:** FY24Q3

Milestone 2: RPM-A v.2 with user interfaces developed; training packages developed.

Start date: FY23Q1; **End date:** FY25Q4

Milestone 3: Assessment of retention interventions complete; plan next iteration.

Start date: FY23Q1; **End date:** FY23Q2

Milestone 4: RPM-A enters scaled use.

Start date: FY25Q1; **End date:** FY25Q4

Task 6.1.c: Army Coaching Program

OPR: ATMTF; **Data Owner(s):** ATMTF, DCS G-1, AG CoE

Change Implementation into Army - Training Internal Coaches.

Army People Strategy: Military Implementation Plan 2.0

Develop a cadre of internal professionally trained coaches capable of providing a minimum of 4,000 hours of coaching a year to 881 Army Leaders per year starting in 2023. The program will have a contract vehicle capable of delivering 8,400 hours of external executive and career coaching support to Field Grade officers and Sergeants Major. Coaching itself will result in SMs who can achieve their goals in the Army, describe themselves using KSBs, increase self-awareness in the most critical leadership positions across the force, and maintain a competitive advantage with the investment in people.

Provide Talent assessment and career navigation through Career Coaching.

Provide Executive Coaching at senior leader levels.

Build internal coaching cadre capacity.

Coach Training pilots initiated 2021 certification through requisite experience will take 2 years (est. 2024-2025).

Internal coaches will be able to do this following training (est. 2023 approx. 100).

Task End State: The program will have a contract vehicle capable of delivering assessment understanding and coaching to Soldiers between the rank of E-6 and Lieutenant Colonel.

Dependencies: Executive coaching provided through contract. It will be 2-3 years before internal coaches have requisite experience (est. 2024-2025)

Task Measures of Effectiveness and Performance:

Measures of Performance:

- Independent survey results
- Registration rate
- Usage rate
- Count of coaches trained

Measures of Effectiveness:

- Increased retention of the right servicemembers that fit the Army mission through coaching

Milestones:

Milestone 1: Establish ACP Headquarters element into Proponency.

Start date: FY22Q4; **End date:** FY22Q4

Milestone 2: Establish ACP Training element at the AG CoE.

Start date: FY23Q1; **End date:** FY23Q3

Milestone 3: Full implementation of the ACP into the Army.

Start date: FY23Q1; **End date:** FY25Q4

Army People Strategy: Military Implementation Plan 2.0

Objective 6.2: Compensate Talent

OPR: DCS G-1; **OCR:** HRC

To complement the shift to the twenty-first century talent-based personnel system, the Army must explore new authorities designed to create appropriate and tailored compensation packages. The Army's goal is to create monetary and non-monetary incentives designed to recognize and retain critical capabilities that will maintain readiness and enhance our ability to overcome adversity in complex environments. This values-based philosophy will enable the Army to identify key personnel who bring added competencies through their responsibility, authority, skills, and mental flexibility during uncertain times.

The APS has this to say about the Objective Compensate: *To complement the shift to the twenty-first century talent-based personnel system, explore new authorities to create appropriate tailored compensation packages that ensure Soldiers and Civilians are valued based on their responsibility, authority, and skills.*

Pay, bonuses, incentives, and other compensation is important in any employment discussion, both as a recruiting tool and as a retention tool. In the Army, pay is generally based upon rank and standardized across all personnel in that rank, with incentive pay based upon the needs of the Army. Therefore, there are two main ways to consider compensation beyond basic pay—either early or temporary promotions, or bonus and incentive pay.

Pay is one of the actions the Army must perform regularly and without fail. At the start of FY23, there were no known pilot programs or new authorities to trial, leading to no tasks on initiation of the FY23-25 MIP, though more may be developed going forward. Despite the lack of tasks, Objective-level measures will be tracked to maintain situational awareness in the space and potentially identify any opportunities for improvement that arise throughout MIP execution.

Objective Measures of Effectiveness and Performance:

- Percentage of brevetable positions filled by breveted Soldiers (*Source: HRC*)
- Percentage of captains who accept a Talent Based Career Alignment out of those who are offered TBCA (*Source: HRC ORD*)
- Percentage of those who are selected for promotion out of those who opt in (goal: **increase**) (*Source: HRC ORD*)
- Percentage of those who accept the Career Intermission Program out of those who apply (*Source: HRC*)
- Percentage of Soldiers in any movement cycle who retire in lieu of reassignment (goal: **decrease**) (*Source: HRC*)

Key Tasks:

None Identified.

Army People Strategy: Military Implementation Plan 2.0

Objective 6.3: Transition Talent

OPR: DCS G-1; **OCR:** HRC

According to the APS, the goal of the Transition objective is to: *Encourage service across the Total Force and create permeability to move between components when it benefits the Army and the individual. Among those choosing to depart, transition them in a way that reinforces a powerful and enduring identity as lifelong members of the Army team, whether as civilian alumni of Army service or as “Soldiers for Life.”*

Critical to this objective is creating an environment where Soldiers, Veterans, and Family members embrace their positive Army experience and serve as Army ambassadors, committed to service, and inspire the next generation to serve in Army formations.

The Army will expand professional development opportunities and encourage transitions across the Total Force by increasing timely, error-free appointments between the Active Duty List (ADL) and Reserve Active Status List (RASL). The Army’s goal is to create permeability initiatives that are beneficial to both the Army and the individual, while reducing the slow and cumbersome appointment process that causes talent loss and harms Army readiness.

Permeability is relatively new to the Army. While transition from the Active component to the Reserve and Guard has long been in existence, to the extent that there are dedicated reserve career counselors that routinely speak to separating Soldiers about the possibilities for continuing their service in the other components, allowing free movement among all three components without separation is a newly developing option. Current capabilities are low, with key administrative and practical considerations being discovered and addressed through pilot programs. As the policies and practicalities mature and the options are made available to the force, the number of Soldiers of all components crossing between them is expected to increase.

Objective Measures of Effectiveness and Performance:

- Count of Soldiers crossing components (goal: **increase**) (Source: HRC)

Key Tasks:

Task 6.3.a: Individual Ready Reserve (IRR) Visibility

OPR: ATMTF; **Data Owner:** HRC RPMD

IRR Visibility seeks to capitalize on talents within the IRR, to establish a “Ready and Responsive” strategic augmentation force. The purpose of the IRR Visibility is to improve muster participation, better educate Soldiers on obligation requirements, and provide seamless transition of IRR Soldiers back to the Regular Army or the Selected Reserve (SELRES). A strategic augmentation IRR force will provide for readiness gaps within the Army.

Army People Strategy: Military Implementation Plan 2.0

Task End State: The Army modernizes the IRR program to encourage and increase active participation through seven lines of effort (LOEs): 1) increase muster participation, 2) educate the force, 3) understand civilian skills inventory, 4) offer incentives, 5) enforce standards, 6) provide opportunities, and 7) execute an internal HRC manpower concept plan.

Dependencies: IPPS-A Release 3 and Release 4

Task Measures of Effectiveness and Performance:

Measures of Performance:

- IRR “Ready and Responsive” program implemented

Measures of Effectiveness:

- Available Soldiers that can mobilize/deploy
- Musters for test population to 90% complete
- IRR Soldiers re-joining Active or SELRES
- DA Civilian Employment Information collected and available
- Appropriately resourced HRC (RPMD) to manage IRR force.

Milestones:

Milestone 1: Decision Brief on continuing to implement IRR Read-E application or utilization of IPPS-A Release 3 with additional requirements identified for Release 4.

Start date: FY23Q1; **End date:** FY25Q4

Milestone 2: Full Implementation of Capability.

Start date: FY25Q4; **End date:** FY26Q3

Milestone 3: Transition to HRC for Enduring Implementation and Expansion.

Start date: FY22Q1; **End date:** FY28Q4

Task 6.3.b: Appointment Permeability

OPR: ATMTF; **Data Owner:** HRC RPMD

Encourage service across the Total Force and create permeability to move between components when it benefits the Army and the individual.

Task End State: Remove disparity within the appointment process in keeping with the Government Accountability Office (GAO) recommendation from 2019 by aligning authorities across components and services, improve timeliness, and standardize process for OSD driven automation efforts.

Dependencies: Department of Defense (DOD) Senior Leader approval of Legislative Proposals. OSD Buy in on automation system and successful Implementation of IPPS-A Release 3 and Release 4.

Army People Strategy: Military Implementation Plan 2.0

Task Measures of Effectiveness and Performance:

Measures of Performance:

- Legislative Proposals Approved out of 4. [FY23 proposal, OLC 208, Updating Authority to Authorize Promotion Transfers Between Components of the Same Service; FY24-26, Updating Authority to Authorize Promotion Transfers Between Components of the Same Service; FY24-27, Updating Appointment Procedures for Regular and Reserve Officers; FY24-28, Updating Appointment Procedures for Army Medical Department Officers.]

Measures of Effectiveness:

- Appointments across compos requiring re-scroll
- Automation Level of Scroll Process

Milestones:

Milestone 1: Analyze the impact of incorporated legislative changes.

Start date: FY23Q1; **End date:** FY24Q3

Milestone 2: Analyze incentives to promote retention/continuum of service for highly qualified officers.

Start date: FY23Q1; **End date:** FY25Q1

Task 6.3.c: Improve the Selective Retention Bonus and Incentives Process

OPR: DCS G-1 DMPM; **Data Owner:** DCS G-1 DMPM

Reform the Army retention program to to increase the effectiveness of monetary incentive determinations.

Task End State: Continued retention success with a reduction in Enlisted retention incentive expenditures.

Dependencies: Completion of RAND study. FY22 Core Project (awaiting signed budget)

Task Measures of Effectiveness and Performance:

Measures of Performance:

- Number of Study Results Implemented

Measures of Effectiveness:

- Continued retention success with a reduction in Enlisted incentives expenditures.

Milestones:

Milestone 1: Contract with RAND to conduct study.

Start date: FY22Q3; **End date:** FY22Q4

Army People Strategy: Military Implementation Plan 2.0

Milestone 2: Execute study and clinical validation.

Start date: FY22Q4; **End date:** FY23Q3

Milestone 3: Validate the SRBM with current Army policies.

Start date: FY23Q4; **End date:** FY24Q2

Milestone 4: Implement SRBM into Retention Incentives Decisions.

Start date: FY24Q3; **End date:** FY25Q1

Task 6.3.d: Modernize Enlisted Retention for First Term Soldiers

OPR: DCS G-1 DMPM; **OCR:** ARI; **Data Owner:** DCS G-1 DMPM

Reform the Army retention program to retain experienced and qualified First Term Soldiers.

Task End State: Improved retention of First Term Soldiers serving in the Active Component

Dependencies: Completion of ARI study.

Task Measures of Effectiveness and Performance:

Measures of Performance:

- Study Results implemented into Policy
- Develop the Soldier-driven retention incentives assessment
- Collect and analyze Soldier-driven retention incentives data and provide recommendations

Measures of Effectiveness:

- Increased retention of Soldiers serving on their First Term of Military Service

Milestones:

Milestone 1: Finalize study proposal and final approval for research agency to execute.

Start date: FY22Q3; **End date:** FY22Q4

Milestone 2: Conduct formal study.

Start date: FY23Q1; **End date:** FY23Q4

Milestone 3: Review and brief results to include recommended changes to DCS G-1 and ASLs.

Start date: FY24Q1; **End date:** FY24Q1

Milestone 4: Implement changes with revision of AR 601-280 and DA PAM 601-280.

Start date: FY24Q2; **End date:** FY24Q3

Army People Strategy: Military Implementation Plan 2.0

Task 6.3.e: Warrant Officers Selected for Continuation Management

OPR: DCS G-1 DMPM; **OCR:** ATMTF; **Data Owner:** DCS G-1 DMPM

Reform warrant officer promotion system to retain experienced and highly skilled technical talent.

Task End State: Improved retention of warrant officers with critical skills and talent

Dependencies: Approval of RAND study. ATMTF POM FY23.

Task Measures of Effectiveness and Performance:

Measures of Performance:

- Legislative Proposals approved and implemented.

Measures of Effectiveness:

- Retention of warrant officers in the rank of CW3 and CW4 with talent and skills to meet critical requirements.

Milestones:

Milestone 1: Develop study proposal and identify research agency.

Start date: FY22Q3; **End date:** FY22Q4

Milestone 2: Conduct formal study.

Start date: FY23Q1; **End date:** FY24Q4

Milestone 3: Review and brief results of Warrant Officer Study to ASL.

Start date: FY25Q1; **End date:** FY25Q1

Milestone 4: Implement changes with FY24 Warrant Officer SELCON board.

Start date: FY25Q2; **End date:** FY26Q1

Task 6.3.f: Review Decision Standards to Support Conservation of Manpower and Retention

OPR: DCS G-1; **Data Owner:** U.S. Army Physical Disability Agency

The decision standards for determining whether a Soldier with medical issues is retained, reclassified, separated for physical disability, or continued in a limited duty status, are largely determined by Service policy. Given the current Army recruiting and retention challenges, a review of these standards, as promulgated in AR 635-40 (a DCS G-1 regulation) may identify warranted revisions that will conserve manpower without undue degradation of readiness. Such review may also identify recommendations for related matters (example: medical retention standards) at both the Department of Defense and Headquarters, Department of the Army (DA) levels. Personnel processes of particular interest include: MOS/Administrative Retention Review (MAR2); Disability

Army People Strategy: Military Implementation Plan 2.0

Evaluation System (DES); and Continuation on Active Duty/Continuation on Active Reserve Status (COAD/COAR).

Task End State: To have realistic decision standards for each program given the current recruiting challenges and competition for talent. For example, are there military occupational specialties and areas of concentration that should be exempt from a worldwide deployability requirement? Should the Army continue to set minimum (fifteen) and maximum (20) years of service for Soldiers to be considered for continuation? Should “continuation” include transfer to another component or another Service?

Dependencies: None Identified.

Task Measures of Effectiveness and Performance:

- Consensus that standards do or do not require revision.
- Identification of MOSs/AOCs exempted from worldwide deployability.
- Increased approvals of continuation requests.

Milestones:

Milestone 1: Form review group composed of colonels.

Start Date: FY23Q1; **End Date:** FY23Q2

Milestone 2: Formal staffing of Army Directive to implement revised standards if necessary.

Start Date: FY23Q3; **End Date:** FY23Q4

Milestone 3: Publication of Army Directive to AR 635-40 if necessary.

Start Date: FY24Q1; **End Date:** FY25Q4



**Chapter 7: Advance Diversity, Equity,
Inclusion, and Accessibility
Military Implementation Plan 2.0**

Army People Strategy: Military Implementation Plan 2.0

DIVERSITY, EQUITY, INCLUSION AND ACCESSIBILITY

Lead integrator: ASA(M&RA)-E&I

Introduction: In accordance with Executive Order 14035 and guidance from the Department of Defense (DoD), the Army developed a Diversity, Equity, Inclusion, and Accessibility (DEIA) strategic plan centered around five fundamental principles. The following principles establish the foundation for the DEIA strategy: 1) Diverse workforce; 2) Equity of opportunity; 3) Inclusive climate and culture; 4) Accessibility enhanced organizations; and 5) Building trust to optimize talent within the Army.

The DEIA Roadmap provides a framework to track the progression of the DEIA policy and implementation initiatives. The DEIA Roadmap ensures the operational and institutional Army remains aligned with the SECARMY’s objectives of creating a diverse and equitable force capable of creating cohesive teams to meet the Army’s mission in a twenty-first century world. This Roadmap focuses the Army’s DEIA efforts from FY23-25, defines how to measure progress, and establishes the frequency of data analytics review to assess the positive growth of the Army culture toward achieving Diversity, Equity, Inclusion, and Accessibility in the workforce.

DEIA’s strategic goals will be implemented along four Lines of Effort (LOEs). Each LOE will provide annual updates to ensure Army-wide compliance and implementation of the Army People Strategy (APS) and the DEIA Roadmap. Figure 11 illustrates the timeline and reporting process, providing a predictable and consistent feedback loop to the office of the Deputy Assistant Secretary for Equity and Inclusion (DASA-EI) and other Department of the Army Headquarters (HQDA) Agencies.

DEIA ROADMAP REVIEW AND REPORTING METRIC												
FISCAL YEAR	2023-2025											
QUARTER OF THE FISCAL YEAR	1ST QTR			2ND QTR			3RD QTR			4TH QTR		
LINES OF EFFORT	OCT	NOV	DEC	JAN	FEB	MAR	APR	MAY	JUN	JULY	AUG	SEP
DIVERSITY	GOAL 1: ENHANCE MISSION READINESS											
EQUITY				GOAL 2: LEADER COMMITMENT AND ENGAGEMENT								
INCLUSION							GOAL 3: TRAINING AND EDUCATION			GOAL 5: ARMY-WIDE INCLUSIVE CULTURE		
ACCESSIBILITY										GOAL 4: THE EMPLOYER OF CHOICE		

Figure 11: DEI Reporting Timeline

The outlined five strategic goals, and 25 tasks represent the next three years of initiatives aligned with three of the SECARMY objectives designed to build and sustain

Army People Strategy: Military Implementation Plan 2.0

the foundational phase of DEIA organizational growth and establish an analytical baseline for future policy decisions.

The DEIA Roadmap aligns with the following SECARMY objectives: (4) Build positive command climate at scale across all Army formations; (5) Reduce harmful behaviors in the Army; and (6) Strategically adapt the way we recruit and retain talent into the Army to sustain the all-volunteer force.

The following definitions of Diversity, Equity, Inclusion, and Accessibility establish a shared understanding and reference across the Army to facilitate future programs and initiatives:

DIVERSITY. All attributes, experiences, cultures, characteristics, and backgrounds of the Total Force which reflect the nation we serve and enable the Army to deploy, fight, and win.

EQUITY. The fair treatment, access, opportunity, choice, and advancement for all Soldiers and DA Civilians while striving to identify and encourage elimination of any barriers that could have prevented the full participation of the Total Force.

INCLUSION. The process of valuing and integrating each individual's perspectives, ideas, and contributions into how an organization functions and makes decisions; enabling workforce members to achieve their full potential in focused pursuit of organizational objectives.

ACCESSIBILITY. Includes the provision of accommodations and modifications to ensure equal access to employment and participation in activities for people with disabilities, and the reduction or elimination of physical and attitudinal barriers to equitable opportunities.

Objective 7.1: Enhance Mission Readiness

(From DEIA LOE 1 – Diversity)

OPR: ASA(M&RA)-E&I; **OCR:** ASA(M&RA)-MP, DCS G-1

The Army will institutionalize Talent Management processes to Acquire, Develop, Employ, and Retain a team of high-performing Soldiers and DA Civilians to address diversity in senior military and civilian leaders. Objective 7.1 is nested with LOEs 3 (Acquire), 4 (Develop), 5 (Employ), and 6 (Retain) of the APS. This objective will be the primary effort for review and reporting every 1st quarter of the Fiscal Year (FY) through 2025. This timeline will ensure initiatives remain current and aligned with Army senior leader guidance regarding the immersion of DEIA practices with Army culture.

Objective End State: The Army performs a comprehensive review of its people processes, policies, programs, and procedures implementing changes that sustain and promote a twenty-first century diverse workforce. It will enable the Army to transform its

Army People Strategy: Military Implementation Plan 2.0

culture to continuously Acquire, Develop, Employ, and Retain the best, most diverse talent available.

Objective Measures of Effectiveness and Performance:

- The measure of performance will track the completion of assigned tasks.
- Measurement of effectiveness will be monitoring career progression for future senior leaders who are more representative of the country and possess the necessary diverse backgrounds to lead the Army in the twenty-first century.

Key Tasks: The following tasks will ensure that all Army policies and strategic plans incorporate the need to Acquire, Develop, Employ, and Retain individuals through career progression and assignment selection. It will enable the establishment and sustainment of cohesive teams comprised of individuals with diverse Knowledge, Skills, Behaviors, and Preferences (KSB-Ps) and backgrounds to change Army culture toward a positive and inclusive environment.

Task 7.1.a. Develop and implement mechanisms to integrate and synergize diversity outreach and goals with Army recruitment strategies to enhance leader participation in acquiring the best talent from diverse backgrounds.

Task 7.1.b. Integrate DEIA principles and policies into the Army Campaign Plan, Army People Strategy, and Army Talent Management processes for all military and civilian personnel.

Task 7.1.c. Establish and implement procedures for achieving desired Army diversity outcomes through diversity policy and talent management principles and practices.

Task 7.1.d. Enhance mentorship, coaching guidance, and processes to ensure professional development opportunities extend across the Army.

Task 7.1.e. Continue to develop and implement procedures that recognize the value of diversity in developing and retaining high-performing Soldiers and DA Civilians.

Objective 7.2: Leader Commitment and Engagement

(From DEIA LOE 2 – Equity)

OPR: ASA(M&RA)-E&I; **OCR:** ASA(M&RA)-TRM

The Army will demonstrate Leader commitment, engagement, and support of DEIA practices at all levels of the Army. Objective 7.2 is nested with LOE 4 (Develop) and, 6 (Retain) of the APS. This goal will be the primary effort for review and reporting every 2nd quarter of the FY through 2025. Additionally, the Army Diversity, Equity, and Inclusion Council (ADEIC) will assess leader engagement and commitment progression on a semi-annual basis. It will enable senior leaders to receive updates on current initiatives, provide guidance, and allocate resources across the Army-wide enterprise.

Army People Strategy: Military Implementation Plan 2.0

Objective End State: Army leaders at all levels value diversity, treat Soldiers and DA Civilians equitably, and create a shared understanding among unit and organizational members regarding the unique KSB-Ps of team members and how they contribute to accomplishing the mission.

Key Tasks: The following tasks will facilitate organizations and institutions within the Army to achieve a future state in which leaders at all levels remain committed and engaged in building cohesive teams and an inclusive environment.

Task 7.2.a. Develop standards, methods, procedures, and processes for implementing DEIA practices.

Task 7.2.b. Integrate diversity principles, equitable treatment, and inclusive leadership practices into leader development.

Task 7.2.c. Develop and implement procedures that ensure continuous leader awareness of DEIA efforts and progress on priority tasks.

Task 7.2.d. Develop recognition and reward programs to incentivize effective DEIA leadership.

Task 7.2.e. Create processes to measure the overall effectiveness of the goals listed in the DEIA Roadmap and progress toward the overall Army People Strategy's strategic outcomes.

Task 7.2.f. Reconstitute an executive-level DEI Council to approve policies, develop requirements, and provide strategic guidance on implementing the DEIA Strategy and executing future initiatives.

Objective 7.3: Training and Education

(From DEIA LOE 3 – Inclusion)

OPR: TRADOC; **OCR:** ASA(M&RA)-E&I

The Army will Implement DEIA training and education programs that meet the demands of the Total Force. Objective 7.3 is nested with LOE 4 (Develop) of the APS. This objective will be the primary effort for review and reporting every 3rd quarter of the FY through 2025.

Objective Measures of Effectiveness and Performance:

- This goal will measure performance based on the completion of tasks
- This goal will measure effectiveness based on the positive growth of underrepresented demographics in senior leadership positions

Objective End State: The Army establishes and incorporates DEI specific training into existing Professional Military Education (PME) at all levels to facilitate an equitable and inclusive environment throughout the Army. This DEI training will augment and support future Equal Employment Opportunity (EEO) and Military Equal Opportunity (MEO)

Army People Strategy: Military Implementation Plan 2.0

professionals in advising Commanders on building and maintaining positive command climates in an inclusive environment.

Key Tasks: The following tasks enable the Army to build and sustain a competitive edge to acquire and retain a competent, diverse workforce capable of solving complex problems. By modernizing training and development, the Army will build and sustain Army readiness capable of defeating competition and adversaries in the twenty-first century.

Task 7.3.a. Develop DEIA training and education programs for each stage of Soldier and DA Civilian career life cycle: pre-commission, entry, mid-career, and senior executive. Provide comprehensive diversity, equity, and inclusion training, diversity advisors, program managers, and other diversity professionals.

Task 7.3.b. Develop and implement a training and education strategy for startup, integration, and sustainment of formal programs.

Task 7.3.c. Develop and implement a comprehensive model for assessing the effectiveness of DEIA training and education, marketing appropriate improvements, and ensuring currency relevancy.

Objective 7.4: The Employer of Choice

(From DEIA LOE 4 – Accessibility)

OPR: ASA(M&RA)-E&I; **OCR:** TRADOC

To support Army DEIA efforts, the Army will Establish and resource a governance structure. Objective 7.4 is nested with LOE 1 (Acquire), LOE 2 (Develop), 3 (Employ), and 4 (Retain) of the APS. This objective will be the primary effort for review and reporting every fourth quarter of the FY through 2025.

Objective Measures of Effectiveness and Performance:

- The measure of performance will track the progression of tasks completed.
- Measure of effectiveness will assess TDA allocations against the need for increased MEO/EEO personnel or a designated DEIA position to be added as an advisor at the unit level.

Objective End State: The Army appropriately resources and staffs Diversity Councils at all levels to advise and assist in implementing all DEIA policies, programs, and initiatives. Additionally, these Diversity Councils will provide continuous monitoring, analysis, and provide feedback to HQDA to ensure Army policies and regulations prevent biases against Soldiers and DA Civilians.

Army People Strategy: Military Implementation Plan 2.0

Key Tasks: The following tasks provide Army policy and a framework for leaders to establish governance boards to process, collect, analyze, and action DEIA issues and concerns within any Army organization.

Task 7.4.a. Study to determine DEIA missions, functions, programs, and required staffing throughout the Army.

Task 7.4.b. Establish or revise governing regulations and policies for DEIA staff and functions.

Task 7.4.c. Establish strategic marketing and communication channels, strategies, and processes that synchronize information related to DEIA across the Total Force.

Task 7.4.d. Study transforming MEO requirements and imperatives to advance diversity, equity, and inclusion.

Task 7.4.e. Study transforming EEO requirements and imperatives to advance diversity, equity, inclusion, and accessibility.

Objective 7.5: Army-Wide Inclusive Culture

(From DEIA LOE 3 – Inclusion)

OPR: ASA(M&RA)-E&I; **OCR:** TRADOC

The Army will create a positive, equitable, and inclusive environment that utilizes diverse attributes, experiences, cultures, and backgrounds to foster cohesive teams and enhance readiness. Objective 5 is nested with APS LOEs 3 (Employ) and 4 (Retain) of the APS. This goal will be the secondary effort for review and reporting every 3rd quarter of the FY through 2025.

Objective Measures of Effectiveness and Performance:

- The measure of performance for this goal will be completing tasks.
- The efficacy of new and updated Army policies will be analyzed through surveys and other feedback methods to illustrate positive growth.

Objective End State: The Army sustains Army-wide listening sessions gaining direct feedback on the success of current programs and initiatives while simultaneously providing Soldiers and DA Civilians a mechanism to identify potential issues. The feedback will enable the Army to remain flexible and competitive in acquiring and retaining twenty-first century talent and demonstrate growth in expanding DEIA principles across the Total Force.

Key Tasks: The following tasks will enable the Army to establish a cultural baseline and show positive growth over time in Army policies on the recruitment and retention of individuals.

Army People Strategy: Military Implementation Plan 2.0

Task 7.5.a. Establish a methodology to benchmark existing organizational climates relevant to DEIA.

Task 7.5.b. Review all Army policies, procedures, and programs for potential biases.

Task 7.5.c. Establish procedures to address DEIA challenges impacting mission readiness.

Task 7.5.d. Establish mechanisms that enable-top-down, lateral, and bottom-up emphasis on equitable and inclusive practices.

Task 7.5.e. Develop practical tools for assessing an equitable and inclusive environment through multiple feedback methods.

DEIA STRATEGIC PLAN MATURITY MODEL:

The Army will establish a DEIA maturity model (**Figure 12**) to annotate, through analytical data, the current state of DEIA immersion in Army Culture. This maturity model allows organizations to transition through the overall DEIA strategy phases seamlessly. Transforming Army culture presents a unique “risk over time” component of the DEIA strategy as generational differences between senior leaders and recruits create constant and ever-shifting barriers toward creating a diverse and inclusive environment. Acknowledging this generational gap, the Army’s DEIA strategic plan and maturity model establishes systems for continuous evaluations. It assesses organizations and leaders to ensure individual and unit cohesion in the future Army culture. **Figure 12** represents the four phases of the Army maturity model:

FOUNDATION: This phase aims to provide the necessary vision and unit infrastructure to address future DEIA policies. Phase 1 clearly articulates any updates or additional policies regarding DEIA and resets the overall command climate providing necessary resources to effect change within the organization.

SUSTAINMENT: This phase focuses on identifying and committing resources to the long-term DEIA strategy identified and articulated in Phase 1. Quarterly and annual training guidance is established and executed at all levels. DEIA champions and other stakeholders identified in Phase 1 are provided DEIA training to establish and sustain “train the trainer” capabilities at all echelons.

PROACTIVE: This phase aims to build upon the organizational success and shift focus toward improving individual growth. The unique focus enables organizations to teach, guide, and assist Soldiers and DA Civilians toward self-actualization and a positive DEIA climate. Once the organizational foundation is established and sustained, the proactive phase assists individual growth through recruitment, mentoring, and assessment.

Army People Strategy: Military Implementation Plan 2.0

ADVOCACY: This phase aims to shift focus from building cohesive teams to enhancing external outreach to families and local communities. DEIA champions, supported by a positive DEIA-focused climate, create an inherent feedback loop for leaders to identify and mitigate any DEIA issues internally while fostering better relations with the local community. This positive external outreach enhances the Army's ability to recruit highly qualified, diverse talent from across the nation.

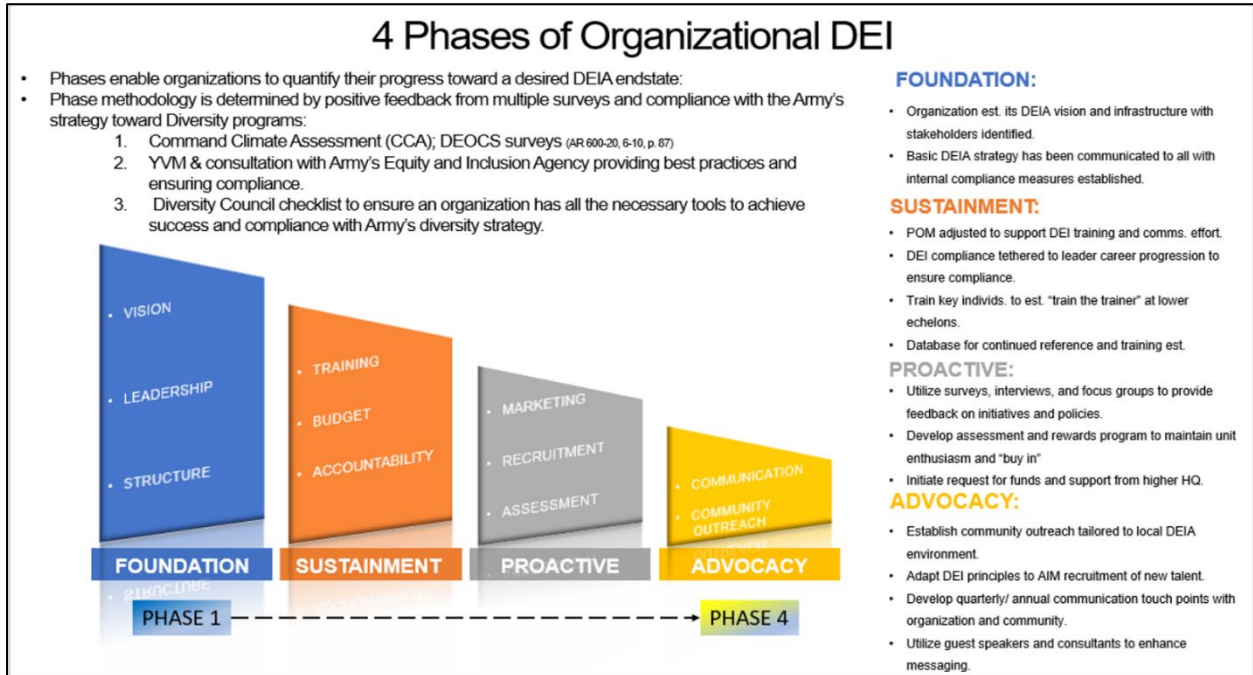

Figure 12: DEI Maturity Model

STRATEGIC OUTCOMES:

This DEIA Roadmap provides a three-year framework to establish a baseline setting conditions to achieve the Army's four strategic DEIA outcomes by 2040. The roadmap enables the overall DEIA strategy to align with the Army People Strategy and the Army Campaign Plan to modernize talent management while maintaining readiness for the Total Force. The strategic outcomes are as follows:

- Build cohesive teams through a modernized, diverse, and ready force
- twenty-first century Leadership Commitment, Engagement, and Accountability
- Sustain inclusive work environments making the Army an Employer of Choice
- Transparent command climates to sustain a positive Army culture

Army People Strategy: Military Implementation Plan 2.0

THE WAY AHEAD:

The Army's vision for its DEIA strategic plan is to be a global leader in DEI. The Army will maintain a competitive advantage by optimizing talent across the Army and building highly capable cohesive teams that can fight and win the nation's wars. The DEIA Roadmap and the APS enable the Army to acquire and retain America's top talent. The Army will maximize its understanding of the diverse attributes, experiences, and backgrounds that Soldiers and DA Civilians bring to the Army and leverage those diverse skills, knowledge, and abilities to maintain twenty-first century readiness and accomplish the Army's mission in a complex world.



**Chapter 8: Build Resiliency
Military Implementation Plan 2.0**

Army People Strategy: Military Implementation Plan 2.0

Build Resiliency

Resilience directly impacts the Army's capacity to fight and win the nation's wars. AR 35-53 Comprehensive Soldier and Family Fitness (CSF2) defines Resilience as: the mental, physical, emotional, and behavioral ability to face and cope with adversity, adapt to change, recover, learn, and grow from setbacks. Psychological well-being and the capability to prepare, adapt, persevere, thrive, and/or grow from dynamic or stressful environments affects the readiness of people, teams, and organizations. Engaged leadership, coupled with integrated primary prevention and response efforts - aimed at reducing harmful behaviors and outcomes, the enhancement of individual and organizational resilience, and the development of positive unit climates and cohesive teams, underpin the strength of the Army.

To support the Army People Strategy, and to develop and achieve the goals of increasing primary prevention and response capabilities across the Force WRT increasing resilience and readiness, the steps outlined in this plan are critical to maintaining and increasing momentum relative to:

- Understanding and leveraging the intersections of environmental factors and behavior
- Growing the knowledge, skills, and abilities to increase Soldier, leader, and unit capabilities that affect resilience
- Optimizing performance and enhancing protective factors
- Aligning and providing the knowledge, skills, and abilities necessary to support the reduction of, and response to, harmful behaviors and mitigate associated risk factors.

The details in this pre-decisional Resilience Annex Implementation Plan outline continued senior leadership involvement, demonstrable progress, clear and enduring implementation mechanisms, and increased transparency. Guided by scientifically driven recommendations, Department of Defense Instruction (DoDI) 6400.09, and informed by the 90-Day Independent Review Commission on Sexual Assault in the Military, the tasks in this plan effectively provide form and substance to current efforts aimed at actively assisting in the reduction of harmful behaviors and outcomes, building cohesion, and strategically buttressing ways in which we retain and develop people. Integrated policy, backed by recognized social science constructs, and strong assessment capabilities provide the data needed to build a comprehensive, holistic, and integrated Army approach towards positively affecting the Army's environment. These Tasks and Milestones represent the programs, policies, research, assessments, and training that work interrelatedly to enhance individual and organizational resilience and prevention and response activities while simultaneously enhancing capabilities for reducing and deterring harmful behavior and outcomes. Measures for some Tasks are still in development pending decisions by Army leadership and the outcomes of several studies.

Army People Strategy: Military Implementation Plan 2.0

Objective 8.1: Assessment and Evaluation

(From Resiliency LOE 1 – Integrated Prevention)

OPR: ARD; **OCR:** ASA(M&RA), DCS G-1, PFTF

End State: Assessment and evaluation framework is implemented, providing sufficient feedback to enable senior leader assessment of the effectiveness of the primary prevention approach (RA 1.0)

Key Tasks:

Task 8.1.a: Execute IRC Rec 2.2.c - Actions for Prevention Workforce

OPR: ARD; **OCR:** ASA(M&RA), DCS G-1

Leaders and Soldiers are engaged in promoting constructive behaviors that lead to an increase in resilience and readiness, and a reduction in undesirable behaviors (RA 1.0).

Dependencies: None Identified.

Task Measures of Effectiveness and Performance:

None Identified. Defaults to Milestone completion status.

Milestones:

Milestone 1: See 8 Milestones re: IRC Tier 1 POAM (Rec 2.2.c)

Start Date: FY22Q1; **End Date:** FY22Q4

Objective 8.2: Strategic Communication and Outreach

(From Resiliency LOE 1 – Integrated Prevention)

OPR: ARD; **OCR:** ASA(M&RA), DCS G-1

Objective End State: Prevention communication strategy that guides actionable efforts to inform Leaders and Soldiers, promote positive behaviors and provide resources to communicate and implement prevention and resilience initiatives.

Key Tasks:

Task 8.2.a: Assess overarching communication and outreach plan

OPR: ARD; **OCR:** ASA(M&RA), DCS G-1

Dependencies: None Identified.

Task Measures of Effectiveness and Performance:

None Identified. Defaults to Milestone completion status.

Milestones:

Milestone 1: Using defined COP, assess programs (SHARP, Resilience, Suicide, Substance Abuse, Health Promotion) to determine gaps between current and future state.

Army People Strategy: Military Implementation Plan 2.0

Start Date: FY22Q2; **End Date:** FY22Q3

Milestone 2: Develop action plans to close gaps

Start Date: FY22Q2; **End Date:** FY22Q3

Milestone 3: Develop updated communicated products as needed

Start Date: FY22Q4; **End Date:** FY23Q4

Task 8.2.b: Inform Audiences of Prevention Capabilities

OPR: ARD; **OCR:** ASA(M&RA), DCS G-1, DCS G-9, PFTF

Leaders and Soldiers are engaged in promoting constructive behaviors that lead to an increase in resilience and readiness, and a reduction in undesirable behaviors (RA 1.0)

Dependencies: None Identified.

Task Measures of Effectiveness and Performance:

None Identified. Defaults to Milestone completion status.

Milestones:

Milestone 1: Field New Army Suicide Prevention Materials

Start Date: FY22Q4; **End Date:** FY25Q4

Task 8.2.c: Inform Audiences of Help-Seeking Resources

OPR: ARD; **OCR:** ASA(M&RA), DCS G-1

Dependencies: None Identified.

Task Measures of Effectiveness and Performance:

None Identified. Defaults to Milestone completion status.

Milestones:

Milestone 1: Field New Army Suicide Prevention Materials

Start Date: FY22Q4; **End Date:** FY25Q4

Task 8.2.d: Inform Command Teams of Responsibilities and Resources

OPR: ARD; **OCR:** ASA(M&RA), DCS G-1, DCS G-9

Dependencies: None Identified.

Task Measures of Effectiveness and Performance:

None Identified. Defaults to Milestone completion status.

Milestones:

Milestone 1: Field New Army Suicide Prevention Materials

Start Date: FY22Q4; **End Date:** FY25Q4

Army People Strategy: Military Implementation Plan 2.0

Objective 8.3: Training and Education

(From Resiliency LOE 1 – Integrated Prevention)

OPR: ARD; **OCR:** ASA(M&RA), DCS G-1

Objective End State: Develop and implement progressive, complimentary training and education activities for leaders, Soldiers, and prevention professionals to impart the knowledge, skills, and attitudes that enable increased protection and reduced risk.

Key Tasks:

Task 8.3.a: Implement Basic Connections Training

OPR: ARD; **OCR:** ASA(M&RA), DCS G-1

Dependencies: None Identified.

Task Measures of Effectiveness and Performance:

None Identified. Defaults to Milestone completion status.

Milestones:

Milestone 1: Establish evaluation plan

Start Date: FY22Q2; **End Date:** FY22Q4

Milestone 2: Conduct Pilot/Field test

Start Date: FY22Q2; **End Date:** FY23Q2

Milestone 3: Publish results of evaluation

Start Date: FY22Q4; **End Date:** FY23Q4

Objective 8.4: Science and Research

(From Resiliency LOE 1 – Integrated Prevention)

OPR: ARD; **OCR:** ASA(M&RA), DCS G-1

Objective End State: Systematic, strategic, and collaborative research plans that comprehensively and proactively support improvements to Soldier resilience and readiness through evidence-based interventions, policies, and programs.

Key Tasks:

Task 8.4.a: Execute Center for Naval Analysis Study on Shared Risk and Protective Factors

OPR: ARD; **OCR:** ASA(M&RA), DCS G-1

Dependencies: None Identified.

Task Measures of Effectiveness and Performance:

None Identified. Defaults to Milestone completion status.

Milestones:

Army People Strategy: Military Implementation Plan 2.0

Milestone 1: Develop study plan

Start Date: FY21Q3; **End Date:** FY21Q4

Milestone 2: Conduct Phase 1: Development of initial integrated model

Start Date: FY21Q4; **End Date:** FY22Q2

Milestone 3: Conduct Phase 2: In-depth review of select prevention programming

Start Date: FY22Q1; **End Date:** FY22Q3

Milestone 4: Conduct Phase 3: Refinement and application of integrated model

Start Date: FY22Q2; **End Date:** FY23Q1

Milestone 5: Review final study results

Start Date: FY23Q1; **End Date:** FY23Q2

Milestone 6: Brief ASLs including potential follow-on

Start Date: FY23Q2; **End Date:** FY25Q4

Task 8.4.b: RAND Understanding Sense of Belonging and Cohesion via Social Media Study

OPR: ARD; **OCR:** ASA(M&RA), DCS G-1

Dependencies: None Identified.

Task Measures of Effectiveness and Performance:

None Identified. Defaults to Milestone completion status.

Milestones:

Milestone 1: Develop study plan, receive approvals, collect data

Start Date: FY21Q3; **End Date:** FY22Q3

Milestone 2: Conduct analyses

Start Date: FY22Q3; **End Date:** FY22Q3

Milestone 3: Draft report

Start Date: FY22Q3; **End Date:** FY22Q3

Milestone 4: Final report published

Start Date: FY22Q3; **End Date:** FY22Q3

Task 8.4.c: Individual Resilience Assessment (IRA)

OPR: ARD; **OCR:** ASA(M&RA), DCS G-1

Dependencies: None Identified.

Task Measures of Effectiveness and Performance:

Army People Strategy: Military Implementation Plan 2.0

None Identified. Defaults to Milestone completion status.

Milestones:

Milestone 1: Develop study plan

Start Date: FY22Q3; **End Date:** FY22Q4

Milestone 2: Receive Institutional Review Board (IRB) and AHRPO approval

Start Date: FY22Q3; **End Date:** FY22Q4

Milestone 3: Conduct Study

Start Date: FY23Q1; **End Date:** FY25Q4

Milestone 4: Review study results

Start Date: FY23Q1; **End Date:** FY25Q4

Milestone 5: Brief ASLs including potential follow-on

Start Date: FY23Q1; **End Date:** FY25Q4

Task 8.4.d: Prevention systems pilot (retreats, PCT, etc.)

OPR: ARD; **OCR:** ASA(M&RA), DCS G-1, DCS G-9, PFTF

Dependencies: None Identified.

Task Measures of Effectiveness and Performance:

None Identified. Defaults to Milestone completion status.

Milestones:

Milestone 1: Develop study plan, receive approvals, collect data

Start Date: FY22Q3; **End Date:** FY23Q2

Milestone 2: Conduct analyses

Start Date: FY23Q1; **End Date:** FY23Q2

Milestone 3: Final report published

Start Date: FY23Q2; **End Date:** FY23Q2

Task 8.4.e: Azimuth Check

OPR: ARD; **OCR:** ASA(M&RA), DCS G-1

Dependencies: None Identified.

Task Measures of Effectiveness and Performance:

None Identified. Defaults to Milestone completion status.

Milestones:

Milestone 1: Finalize new questions, develop scoring algorithms

Army People Strategy: Military Implementation Plan 2.0

Start Date: FY22Q1; **End Date:** FY23Q2

Milestone 2: Launch new survey and contents

Start Date: FY23Q2; **End Date:** FY25Q4

Milestone 3: Analyze user feedback and time spent on resources

Start Date: FY23Q3; **End Date:** FY25Q4

Milestone 4: Revise as needed

Start Date: FY23Q1; **End Date:** FY25Q4

Task 8.4.f: Behavioral Health Pulse 2.0

OPR: ARD; **OCR:** ASA(M&RA), DCS G-1

Dependencies: None Identified.

Task Measures of Effectiveness and Performance:

None Identified. Defaults to Milestone completion status.

Milestones:

Milestone 1: Continuing Unit Assessments

Start Date: FY23Q1; **End Date:** FY25Q4

Task 8.4.g: Plan and oversee research and disseminate findings/recs on integrated prevention, IN addition to studies above

OPR: ARD; **OCR:** ASA(M&RA), DCS G-1

Dependencies: None Identified.

Task Measures of Effectiveness and Performance:

None Identified. Defaults to Milestone completion status.

Milestones:

Milestone 1: Develop study plans and receive approvals for research on integrated prevention, including cross-cutting risk/protective factors and/or climate/culture specific to integrated prevention

Start Date: FY22Q2; **End Date:** FY25Q4

Milestone 2: Conduct analyses for research on integrated prevention, including cross-cutting risk/protective factors and/or climate/culture specific to integrated prevention

Start Date: FY23Q1; **End Date:** FY25Q4

Milestone 3: Publish final reports for research on integrated prevention, including cross-cutting risk/protective factors and/or climate/culture specific to integrated prevention

Start Date: FY23Q1; **End Date:** FY25Q4

Army People Strategy: Military Implementation Plan 2.0

Task 8.4.h: RAND Developing and Implementing a Pulse Infrastructure

OPR: ARD; **OCR:** ASA(M&RA), DCS G-1

Dependencies: None Identified.

Task Measures of Effectiveness and Performance:

None Identified. Defaults to Milestone completion status.

Milestones:

Milestone 1: Develop study plans and receive approvals

Start Date: FY22Q3; **End Date:** FY23Q2

Milestone 2: Collect Data

Start Date: FY23Q2; **End Date:** FY23Q3

Objective 8.5: Information Management / Knowledge Management Assessment
(From Resiliency LOE 2 – Information Management / Knowledge Management)

OPR: ARD; **OCR:** ASA(M&RA), DCS G-1

Systematic assessment of Risk and Resiliency (R2) information, information architecture, and resulting knowledge management processes to evaluate their efficacy in information leader decisions and policy design.

Objective End State: Across the Force, Leaders have access to R2 information, the capability to conduct operational analysis, and the understanding to make informed decisions regarding comprehensive readiness and resilience actions. IM processes, platforms, and concepts are integrated, effective, and enable KM processes. KM operations facilitate effective knowledge flow and shared understanding to enable effective outcomes and informed leader decisions.

Key Tasks:

Task 8.5.a: Establish Assessment Metrics

OPR: ARD; **OCR:** ASA(M&RA), DCS G-1

Dependencies: None Identified.

Task Measures of Effectiveness and Performance:

None Identified. Defaults to Milestone completion status.

Milestones:

Milestone 1: Determine efficacy of data from all R2 systems

Start Date: FY22Q3; **End Date:** FY23Q2

Milestone 2: Establish baseline benchmarks for all R2 systems

Army People Strategy: Military Implementation Plan 2.0

Start Date: FY23Q2; **End Date:** FY23Q4

Task 8.5.b: Feedback from users

OPR: ARD; **OCR:** ASA(M&RA), DCS G-1

Dependencies: None Identified.

Task Measures of Effectiveness and Performance:

Measures of Performance:

- Frequency and feedback mechanism
- Impactful feedback

Measures of Effectiveness:

- Unbiased feedback from Users

Milestones:

Milestone 1: Create feedback mechanism (Survey, meetings etc.) and establish frequency

Start Date: FY23Q1; **End Date:** FY24Q2

Milestone 2: Engage users for assessment feedback

Start Date: FY24Q2; **End Date:** FY24Q4

Task 8.5.c: Analyze Feedback

OPR: ARD; **OCR:** ASA(M&RA), DCS G-1

Dependencies: None Identified.

Task Measures of Effectiveness and Performance:

Measures of Performance:

- Feedback
- Additional requirements
- New functionality

Measures of Effectiveness:

- Correct feedback assessment and implementation

Milestones:

Milestone 1: Review Feedback

Start Date: FY24Q4; **End Date:** FY25Q1

Milestone 2: Create new requirements from feedback

Start Date: FY25Q1; **End Date:** FY25Q3

Milestone 3: Test and Implement new functionality

Army People Strategy: Military Implementation Plan 2.0

Start Date: FY25Q3; **End Date:** FY25Q3

Objective 8.6: Information Management Framework

(From Resiliency LOE 2 – Information Management / Knowledge Management)

OPR: ARD; **OCR:** ASA(M&RA), DCS G-1

Conduct cyclic monitoring and evaluation of R2 data framework execution (acquisition, storage and safeguarding, user access, and technology) with respect to designated tasks, objectives, and goals.

Objective End State: Across the Force, Leaders have access to R2 information, the capability to conduct operational analysis, and the understanding to make informed decisions regarding comprehensive readiness and resilience actions. IM processes, platforms, and concepts are integrated, effective, and enable KM processes. KM operations facilitate effective knowledge flow and shared understanding to enable effective outcomes and informed leader decisions

Key Tasks:

Task 8.6.a: Provide sufficient resources for monitoring and evaluation.

OPR: ARD; **OCR:** ASA(M&RA), DCS G-1

Dependencies: None Identified.

Task Measures of Effectiveness and Performance:

Measures of Performance:

- Acquisition Criteria
- Storage evaluation

Measures of Effectiveness:

- Appropriate Criteria Utilized for evaluation

Milestones:

Milestone 1: Develop, monitor and evaluation acquisition criteria

Start Date: FY22Q3; **End Date:** FY23Q1

Milestone 2: Monitor and evaluate storage framework

Start Date: FY22Q3; **End Date:** FY23Q1

Task 8.6.b: Risk Management Framework (RMF) Standards

OPR: ARD; **OCR:** ASA(M&RA), DCS G-1

Dependencies: None Identified.

Task Measures of Effectiveness and Performance:

Army People Strategy: Military Implementation Plan 2.0

Measures of Performance:

- Secure environment
- Secure access

Measures of Effectiveness:

- Comply with RMF standards

Milestones:

Milestone 1: Review and comply with safeguarding requirements

Start Date: FY22Q3; **End Date:** FY23Q2

Milestone 2: Review and maintain User Access standards

Start Date: FY22Q2; **End Date:** FY22Q4

Task 8.6.c: Create Data Framework to support changing requirements

OPR: ARD; **OCR:** ASA(M&RA), DCS G-1

Dependencies: None Identified.

Task Measures of Effectiveness and Performance:

Measures of Performance:

- Requirements reprioritized
- Framework updated

Measures of Effectiveness:

- Identify new and changing requirements

Milestones:

Milestone 1: Reprioritize requirements

Start Date: FY22Q4; **End Date:** FY23Q2

Milestone 2: Update framework

Start Date: FY23Q3; **End Date:** FY24Q4

Objective 8.7: Knowledge Management Process Assessment

(From Resiliency LOE 2 – Information Management / Knowledge Management)

OPR: ARD; **OCR:** ASA(M&RA), DCS G-1

Conduct cyclic monitoring and evaluation of R2 KM processes (analyze, share, and present/disseminate), at multiple echelons, and ensure they facilitate shared understanding, decision-making, and actions.

Objective End State: Across the Force, Leaders have access to R2 information, the capability to conduct operational analysis, and the understanding to make informed decisions regarding comprehensive readiness and resilience actions. IM processes,

Army People Strategy: Military Implementation Plan 2.0

platforms, and concepts are integrated, effective, and enable KM processes. KM operations facilitate effective knowledge flow and shared understanding to enable effective outcomes and informed leader decisions.

Key Tasks:

Task 8.7.a: Establish KM Metrics

OPR: ARD; **OCR:** ASA(M&RA), DCS G-1

Dependencies: None Identified.

Task Measures of Effectiveness and Performance:

Measures of Performance:

- Key process
- Redundancy

Measures of Effectiveness:

- Correct R2 systems assessment

Milestones:

Milestone 1: Identify key processes for each R2 System

Start Date: FY22Q4; **End Date:** FY23Q2

Milestone 2: Replicate critical processes across the R2 footprint

Start Date: FY23Q3; **End Date:** FY23Q4

Task 8.7.b: Feedback from users at various echelons

OPR: ARD; **OCR:** ASA(M&RA), DCS G-1

Dependencies: None Identified.

Task Measures of Effectiveness and Performance:

Measures of Performance:

- Feedback to improve
- New requirements
- Working in process

Measures of Effectiveness:

- Collect unbiased feedback
- Mapping feedback to requirements

Milestones:

Milestone 1: Review Feedback

Army People Strategy: Military Implementation Plan 2.0

Start Date: FY23Q3; **End Date:** FY23Q3

Milestone 2: Create new requirements from feedback

Start Date: FY23Q4; **End Date:** FY24Q1

Milestone 3: Test and Implement new processes

Start Date: FY24Q1; **End Date:** FY24Q3

Task 8.7.c: Revise monitoring and evaluation Metrics

OPR: ARD; **OCR:** ASA(M&RA), DCS G-1

Dependencies: None Identified.

Task Measures of Effectiveness and Performance:

Measures of Performance:

- Risk mitigation strategies
- Revised metrics

Measures of Effectiveness:

- Reduce or Eliminate risk
- Identify key process

Milestones:

Milestone 1: Identify risks and mitigation strategies

Start Date: FY23Q3; **End Date:** FY23Q4

Milestone 2: Prioritize key processes and adjust evaluation

Start Date: FY24Q1; **End Date:** FY24Q3

Objective 8.8: Structure and Execution

(From Resiliency LOE 2 – Information Management / Knowledge Management)

OPR: ARD; **OCR:** ASA(M&RA), DCS G-1

Implement framework that addresses assessment findings and ensures R2 IM / KM platforms are effective in providing Leaders the information and knowledge necessary to make informed resilient and readiness decisions.

Objective End State: Across the Force, Leaders have access to R2 information, the capability to conduct operational analysis, and the understanding to make informed decisions regarding comprehensive readiness and resilience actions. IM processes, platforms, and concepts are integrated, effective, and enable KM processes. KM operations facilitate effective knowledge flow and shared understanding to enable effective outcomes and informed leader decisions.

Army People Strategy: Military Implementation Plan 2.0

Key Tasks:

Task 8.8.a: Develop Courses of Action (COAs) based on assessment findings

OPR: ARD; **OCR:** ASA(M&RA), DCS G-1

Dependencies: None Identified.

Task Measures of Effectiveness and Performance:

Measures of Performance:

- New requirements
- Updated process/technology
- New IM/KM Framework

Measures of Effectiveness:

- Implementing feedback
- Align new process with feedback

Milestones:

Milestone 1: Define new requirements from feedback

Start Date: FY23Q3; **End Date:** FY24Q1

Milestone 2: Adjust process/technology to support findings

Start Date: FY24Q2; **End Date:** FY24Q2

Milestone 3: Testing and Implementing new IM/KM framework

Start Date: FY24Q3; **End Date:** FY24Q4

Objective 8.9: Visibility Processes

(From Resiliency LOE 2 – Information Management / Knowledge Management)

OPR: ARD; **OCR:** ASA(M&RA), DCS G-1

Provide Leaders a comprehensive visibility tool, comprised of easily understood and accessible data and information, which enables Leaders increased knowledge and allows them to make informed R2 decisions and action-informed prevention and response decisions.

Objective End State: Across the Force, Leaders have access to R2 information, the capability to conduct operational analysis, and the understanding to make informed decisions regarding comprehensive readiness and resilience actions. IM processes, platforms, and concepts are integrated, effective, and enable KM processes. KM operations facilitate effective knowledge flow and shared understanding to enable effective outcomes and informed leader decisions.

Army People Strategy: Military Implementation Plan 2.0

Key Tasks:

Task 8.9.a: Comprehensive requirements for visibility tool

OPR: ARD; **OCR:** ASA(M&RA), DCS G-1

Dependencies: None Identified.

Task Measures of Effectiveness and Performance:

Measures of Performance:

- Visibility working group
- Key requirements

Measures of Effectiveness:

- Stakeholder identification
- Collect requirements

Milestones:

Milestone 1: Create a Visibility working groups with stakeholders

Start Date: FY23Q1; **End Date:** FY23Q2

Milestone 2: Identify key requirements and outputs

Start Date: FY24Q3; **End Date:** FY24Q4

Task 8.9.b: New or Missing capability

OPR: ARD; **OCR:** ASA(M&RA), DCS G-1

Dependencies: None Identified.

Task Measures of Effectiveness and Performance:

Measures of Performance:

- Survey
- New Functionality

Measures of Effectiveness:

- Right Survey Population

Milestones:

Milestone 1: Survey the field

Start Date: FY22Q4; **End Date:** FY23Q4

Milestone 2: Review, test and implement additional functionality

Start Date: FY24Q1; **End Date:** FY24Q4

Army People Strategy: Military Implementation Plan 2.0

Objective 8.10: Continuum of Visibility Processes

(From Resiliency LOE 2 – Information Management / Knowledge Management)

OPR: ARD; **OCR:** ASA(M&RA), DCS G-1

Mutually supporting IM / KM systems and processes are developed and implemented to generate enhanced Leader shared understanding of operationalized prevention, response, and resilience data.

Objective End State: Across the Force, Leaders have access to R2 information, the capability to conduct operational analysis, and the understanding to make informed decisions regarding comprehensive readiness and resilience actions. IM processes, platforms, and concepts are integrated, effective, and enable KM processes. KM operations facilitate effective knowledge flow and shared understanding to enable effective outcomes and informed leader decisions.

Key Tasks:

Task 8.10.a: Training users on correct use of the system

OPR: ARD; **OCR:** ASA(M&RA), DCS G-1

Dependencies: None Identified.

Task Measures of Effectiveness and Performance:

Measures of Performance:

- Provide training
- Training updated

Measures of Effectiveness:

- Training meets standards

Milestones:

Milestone 1: Provide initial and reoccurring training

Start Date: FY23Q1; **End Date:** FY25Q4

Milestone 2: Maintain and update training with respect to system changes over time

Start Date: FY23Q1; **End Date:** FY25Q4

Task 8.10.b: Feedback

OPR: ARD; **OCR:** ASA(M&RA), DCS G-1

Dependencies: None Identified.

Task Measures of Effectiveness and Performance:

Measures of Performance:

- Feedback

Army People Strategy: Military Implementation Plan 2.0

Measures of Effectiveness:

- Implementing feedback

Milestones:

Milestone 1: Review and implement feedback

Start Date: FY23Q1; **End Date:** FY25Q4

Objective 8.11: Communication and Outreach

From Resiliency LOE 2 – Information Management / Knowledge Management

OPR: ARD; **OCR:** ASA(M&RA), DCS G-1

Provide resources that instill knowledge and facilitate shared understanding to build capacity, positively impact Army culture, and reinforce the value of prevention, response, and resiliency programs.

Objective End State: Across the Force, Leaders have access to R2 information, the capability to conduct operational analysis, and the understanding to make informed decisions regarding comprehensive readiness and resilience actions. IM processes, platforms, and concepts are integrated, effective, and enable KM processes. KM operations facilitate effective knowledge flow and shared understanding to enable effective outcomes and informed leader decisions.

Key Tasks:

Task 8.11.a: Facilitate Access to ARD Resources

OPR: ARD; **OCR:** ASA(M&RA), DCS G-1

Dependencies: None Identified.

Task Measures of Effectiveness and Performance:

None Identified. Defaults to Milestone completion status.

Milestones:

Milestone 1: Advertise POD Site-SAAPM Memo

Start Date: FY21Q2; **End Date:** FY22Q2

Milestone 2: Advertise POD Site-Suicide Prevention Month Memo

Start Date: FY21Q4; **End Date:** FY22Q3

Task 8.11.b: RAND Understanding Soldier's experiences with Sexual Harassment (SH) and Gender Discrimination (GD)

OPR: ARD; **OCR:** ASA(M&RA), DCS G-1

Dependencies: None Identified.

Task Measures of Effectiveness and Performance:

Army People Strategy: Military Implementation Plan 2.0

None Identified. Defaults to Milestone completion status.

Milestones:

Milestone 1: Develop study plan, receive approvals, and transfer data

Start Date: FY22Q3; **End Date:** FY23Q2

Milestone 2: Collect data

Start Date: FY23Q4; **End Date:** FY23Q4

Milestone 3: Conduct analyses

Start Date: FY24Q1; **End Date:** FY24Q3

Milestone 4: Publish report

Start Date: FY24Q3; **End Date:** FY25Q1

Objective 8.12: Training and Education

From Resiliency LOE 2 – Information Management / Knowledge Management

OPR: ARD; **OCR:** ASA(M&RA), DCS G-1

Leaders, Soldiers, and supporting functional specialists are educated, trained, and equipped with the knowledge, skills, and tools to support shared understanding and effective decision-making within the operations process.

Objective End State: Across the Force, Leaders have access to R2 information, the capability to conduct operational analysis, and the understanding to make informed decisions regarding comprehensive readiness and resilience actions. IM processes, platforms, and concepts are integrated, effective, and enable KM processes. KM operations facilitate effective knowledge flow and shared understanding to enable effective outcomes and informed leader decisions.

Key Tasks:

Task 8.12.a: Conduct Needs analysis for IM/KM Training and Education

OPR: ARD; **OCR:** ASA(M&RA), DCS G-1

Dependencies: None Identified.

Task Measures of Effectiveness and Performance:

None Identified. Defaults to Milestone completion status.

Milestones:

Milestone 1: Survey IM/KM user base to determine gaps in knowledge

Start Date: FY22Q4; **End Date:** FY23Q1

Army People Strategy: Military Implementation Plan 2.0

Milestone 2: Coordinate with S&R and Assessments to determine requirements for IM/KM utilization

Start Date: FY23Q2; **End Date:** FY23Q2

Milestone 3: Produce IM/KM training and education requirements report

Start Date: FY23Q4; **End Date:** FY23Q2

Task 8.12.b: Develop IM/KM training and education curriculum

OPR: ARD; **OCR:** ASA(M&RA), DCS G-1

Dependencies: None Identified.

Task Measures of Effectiveness and Performance:

None Identified. Defaults to Milestone completion status.

Milestones:

Milestone 1: Determine requirements based on needs analysis

Start Date: FY23Q3; **End Date:** FY23Q4

Milestone 2: Coordinate with Resourcing to determine funding and manning requirements (if needed)

Start Date: FY22Q4; **End Date:** FY23Q1

Milestone 3: Produce IM/KM training and education timeline for stakeholders

Start Date: FY23Q2; **End Date:** FY23Q2

Objective 8.13: Science and Research

From Resiliency LOE 2 – Information Management / Knowledge Management

OPR: ARD; **OCR:** ASA(M&RA), DCS G-1

Strategic, systematic, and scientific research efforts inform development of tools to proactively support Leader information, knowledge, and decisions and improvements to Soldier resilience and readiness.

Objective End State: Across the Force, Leaders have access to R2 information, the capability to conduct operational analysis, and the understanding to make informed decisions regarding comprehensive readiness and resilience actions. IM processes, platforms, and concepts are integrated, effective, and enable KM processes. KM operations facilitate effective knowledge flow and shared understanding to enable effective outcomes and informed leader decisions.

Army People Strategy: Military Implementation Plan 2.0

Key Tasks:

Task 8.13.a: Plan, oversee and disseminate findings/recs from research-based operational surveys- Army Fit, BH Pulse, Azimuth Check as applicable

OPR: ARD; **OCR:** ASA(M&RA), DCS G-1

Dependencies: None Identified.

Task Measures of Effectiveness and Performance:

None Identified. Defaults to Milestone completion status.

Milestones:

Milestone 1: Plan operational survey topics, survey support and funding sources for research-based operational surveys

Start Date: FY22Q1; **End Date:** FY25Q4

Milestone 2: Oversee operational survey design, approvals, execution, analysis, interpretation, and write-up of results/recommendations

Start Date: FY22Q1; **End Date:** FY25Q4

Milestone 3: Disseminate findings/recs through briefs, information papers, Army products and, if/when appropriate, published reports from research-based operational surveys

Start Date: FY22Q1; **End Date:** FY25Q4

Task 8.13.b: Behavioral Health Readiness and Suicide Risk Reduction Review (R4) Pilot and Implementation

OPR: ARD; **OCR:** ASA(M&RA), DCS G-1

Dependencies: None Identified.

Task Measures of Effectiveness and Performance:

Measures of Performance:

- Approved slide deck outlining pilot results recommendations, ready ASL briefs
- Pilot findings presented in understandable and actionable way, to inform evidence based R4

Measures of Effectiveness:

- Evidence based decision has been made on R4 implementation

Milestones:

Milestone 1: Conduct Pilot

Start Date: FY19Q3; **End Date:** FY21Q4

Milestone 2: Implement decisions (in progress/pending ASL briefs), including potential follow-on studies/pilots

Army People Strategy: Military Implementation Plan 2.0

Start Date: FY22Q1; **End Date:** FY22Q3

Milestone 3: Create curriculum

Start Date: FY22Q1; **End Date:** FY22Q3

Milestone 4: Pilot Training

Start Date: FY23Q1; **End Date:** FY25Q4

Task 8.13.c: Institute for Defense Analyses (IDA) suicide study

OPR: ARD; **OCR:** ASA(M&RA), DCS G-1

Dependencies: None Identified.

Task Measures of Effectiveness and Performance:

Measures of Performance:

- IRB and AHRPO approved study plan, ready to execute study
- IDA has received encrypted files for randomly generated sample according to study design
- IDA delivers preliminary findings for ARD Review
- Report is publicly available on IDA's website

Measures of Effectiveness:

- IRB approval memo and AHRPO approval memos document human subjects protections and scientific merit
- IDA Data set has received complete, securely transferred data set, ready for analysis
- Preliminary findings are understandable and actionable

Milestones:

Milestone 1: Crosswalk data and transfer Data

Start Date: FY22Q1; **End Date:** FY22Q3

Milestone 2: Conduct analyses

Start Date: FY22Q3; **End Date:** FY23Q1

Milestone 3: Final Report Published

Start Date: FY23Q1; **End Date:** FY23Q2

Task 8.13.d: RAND Mindfulness systematic lit review

OPR: ARD; **OCR:** ASA(M&RA), DCS G-1

Dependencies: None Identified.

Task Measures of Effectiveness and Performance:

Army People Strategy: Military Implementation Plan 2.0

Measures of Performance:

- Report is publicly available on RAND's website

Measures of Effectiveness:

- Report is publicly available on RAND's website

Milestones:

Milestone 1: Final report published

Start Date: FY22Q3; **End Date:** FY22Q3

Task 8.13.e: RAND Difficult Conversations

OPR: ARD; **OCR:** ASA(M&RA), DCS G-1

Dependencies: None Identified.

Task Measures of Effectiveness and Performance:

None Identified. Defaults to Milestone completion status.

Milestones:

Milestone 1: Conduct analyses

Start Date: FY22Q1; **End Date:** FY22Q2

Milestone 2: Final report published

Start Date: FY22Q2; **End Date:** FY22Q2

Task 8.13.f: Machine Learning Models for Suicide Prevention

OPR: ARD; **OCR:** ASA(M&RA), DCS G-1

Dependencies: None Identified.

Task Measures of Effectiveness and Performance:

None Identified. Defaults to Milestone completion status.

Milestones:

Milestone 1: Pilot Programs to inform clinicians of Suicide Risk

Start Date: FY23Q1; **End Date:** FY25Q4

Milestone 2: Evaluate Pilot Programs

Start Date: FY23Q1; **End Date:** FY25Q4

Task 8.13.g: In addition to studies above, Plan and oversee research and disseminate findings/recs on ARD substantive areas of focus (suicide, ASAP, resilience) other than topics covered in SHARP TAPS)

OPR: ARD; **OCR:** ASA(M&RA), DCS G-1

Army People Strategy: Military Implementation Plan 2.0

Dependencies: None Identified.

Task Measures of Effectiveness and Performance:

None Identified. Defaults to Milestone completion status.

Milestones:

Milestone 1: Develop study plans and receive approvals for research on suicide, resilience, Soldier wellbeing, risk/protective factors specific to ARD substantive areas of focus; and/or climate/culture specific to ARD substantive areas of focus.

Start Date: FY22Q2; **End Date:** FY25Q4

Milestone 2: Conduct analyses for research on suicide, resilience, Soldier wellbeing, risk/protective factors specific to ARD substantive areas of focus; and/or climate/culture specific to ARD substantive areas of focus.

Start Date: FY23Q1; **End Date:** FY25Q4

Milestone 3: Publish final reports for research on suicide, resilience, Soldier wellbeing, risk/protective factors specific to ARD substantive areas of focus; and/or climate/culture specific to ARD substantive areas of focus.

Start Date: FY23Q1; **End Date:** FY25Q4

Task 8.13.h: RAND Understanding Suicide risk among Soldiers

OPR: ARD; **OCR:** ASA(M&RA), DCS G-1

Dependencies: None Identified.

Task Measures of Effectiveness and Performance:

None Identified. Defaults to Milestone completion status.

Milestones:

Milestone 1: Develop study plans, receive approvals, transfer data

Start Date: FY22Q3; **End Date:** FY22Q4

Milestone 2: Conduct analyses

Start Date: FY22Q4; **End Date:** FY23Q3

Milestone 3: Publish final reports

Start Date: FY23Q3; **End Date:** FY24Q1

Objective 8.14: Sustainment

From Resiliency LOE 2 – Information Management / Knowledge Management

OPR: ARD; **OCR:** ASA(M&RA), DCS G-1

Army People Strategy: Military Implementation Plan 2.0

Objective End State: Ensure realized capabilities, efficacies and outcomes of R2 IM and KM constructs and platforms are maintained and supported through continuous feedback and refinements to inform effective R2 decision making.

Key Tasks:

Task 8.14.a: Established QA/QC Metrics

OPR: ARD; **OCR:** ASA(M&RA), DCS G-1

Dependencies: None Identified.

Task Measures of Effectiveness and Performance:

Measures of Performance:

- IM/KM Metrics
- New IM/KM Metrics
- IM/KM Benchmarks

Measures of Effectiveness:

- Qualifiable and Measurable
- Metrics align with Milestones
- Benchmarks are relevant

Milestones:

Milestone 1: IM/KM Metrics established

Start Date: FY22Q3; **End Date:** FY23Q2

Milestone 2: IM/KM Metrics analyzed semi-annually

Start Date: FY23Q2; **End Date:** FY23Q3

Milestone 3: Benchmarks established

Start Date: FY23Q4; **End Date:** FY23Q4

Task 8.14.b: Revise QA/QC Metrics overtime

OPR: ARD; **OCR:** ASA(M&RA), DCS G-1

Dependencies: None Identified.

Task Measures of Effectiveness and Performance:

Measures of Performance:

- Changes
- Adjusted metrics

Measures of Effectiveness:

- Changes are prioritized
- Metrics are aligned with Milestones

Army People Strategy: Military Implementation Plan 2.0

Milestones:

Milestone 1: Identify changes to R2 systems

Start Date: FY24Q1; **End Date:** FY24Q2

Milestone 2: Adjust Metrics

Start Date: FY24Q3; **End Date:** FY24Q4

Objective 8.15: Resilience Assessment and Evaluation

From Resiliency LOE 3 – Resilience, Suicide Prevention Program, and Army Substance Abuse Program

OPR: ARD; **OCR:** ASA(M&RA), DCS G-1

Assessment and evaluation framework is implemented, providing sufficient feedback to enable senior leader assessment of the effectiveness of the comprehensive response approach.

Objective End State: Conditions, individual and collective, have been transformed, restored, or sustained to enable optimal resilience and performance.

Key Tasks:

Task 8.15.a: Assess the Comprehensive Soldier and Family Fitness (CSF2) and Resilience Program

OPR: ARD; **OCR:** ASA(M&RA), DCS G-1

Dependencies: None Identified.

Task Measures of Effectiveness and Performance:

None Identified. Defaults to Milestone completion status.

Milestones:

Milestone 1: Select MFA recommendations for action

Start Date: FY22Q2; **End Date:** FY22Q4

Milestone 2: Submit service evaluation plan to Director

Start Date: FY22Q2; **End Date:** FY22Q4

Milestone 3: Pilot enterprise-wide metrics for each program function, evaluate results

Start Date: FY22Q2; **End Date:** FY22Q3

Milestone 4: Publish enterprise-wide PMI for CSF2

Start Date: FY22Q3; **End Date:** FY23Q1

Army People Strategy: Military Implementation Plan 2.0

Objective 8.16: Resilience Strategic Communication and Outreach

From Resiliency LOE 3 – Resilience, Suicide Prevention Program, and Army Substance Abuse Program

OPR: ARD; **OCR:** ASA(M&RA), DCS G-1

Promote trust and confidence across the force and among the American public in the Army's ability to provide professional and compassionate care and support to Soldiers, DA Civilians, and Family members through a comprehensive response system.

Objective End State: Conditions, individual and collective, have been transformed, restored, or sustained to enable optimal resilience and performance.

Key Tasks:

Task 8.16.a: Develop and execute annual Resilience communication plan

OPR: ARD; **OCR:** ASA(M&RA), DCS G-1

Dependencies: None Identified.

Task Measures of Effectiveness and Performance:

None Identified. Defaults to Milestone completion status.

Milestones:

Milestone 1: Execute Annual Communication Plan

Start Date: FY22Q2; **End Date:** FY22Q4

Milestone 2: Assess Annual Communication Plan

Start Date: FY23Q1; **End Date:** FY23Q3

Milestone 3: Review results/identify lessons learned/areas for improvement

Start Date: FY23Q2; **End Date:** FY23Q3

Objective 8.17: Suicide Prevention Program Assessment and Evaluation

From Resiliency LOE 3 – Resilience, Suicide Prevention Program, and Army Substance Abuse Program

OPR: ARD; **OCR:** ASA(M&RA), DCS G-1

Assessment and evaluation framework is implemented, providing sufficient feedback to enable senior leader assessment of the effectiveness of the comprehensive response approach.

Objective End State: Conditions, individual and collective, have been transformed, restored, or sustained to enable optimal resilience and performance.

Key Tasks:

Army People Strategy: Military Implementation Plan 2.0

Task 8.17.a: Assess the suicide prevention program

OPR: ARD; **OCR:** ASA(M&RA), DCS G-1

Dependencies: None Identified.

Task Measures of Effectiveness and Performance:

None Identified. Defaults to Milestone completion status.

Milestones:

Milestone 1: Submit service evaluation plan to DSPO

Start Date: FY22Q2; **End Date:** FY22Q4

Milestone 2: Pilot enterprise-wide metrics for each program function, evaluate results

Start Date: FY22Q2; **End Date:** FY22Q2

Milestone 3: Publish enterprise-wide PMI for Army Suicide Prevention Program

Start Date: FY22Q3; **End Date:** FY23Q1

Objective 8.18: Suicide Prevention Program Strategic Communication and Outreach

From Resiliency LOE 3 – Resilience, Suicide Prevention Program, and Army Substance Abuse Program

OPR: ARD; **OCR:** ASA(M&RA), DCS G-1

Promote trust and confidence across the force and among the American public in the Army's ability to provide professional and compassionate care and support to Soldiers, DA Civilians, and Family members through a comprehensive response system.

Objective End State: Conditions, individual and collective, have been transformed, restored, or sustained to enable optimal resilience and performance.

Key Tasks:

Task 8.18.a: Develop and execute annual SP communication plan that includes the "Connect to Protect: Support is Within Reach" theme

OPR: ARD; **OCR:** ASA(M&RA), DCS G-1

Dependencies: None Identified.

Task Measures of Effectiveness and Performance:

None Identified. Defaults to Milestone completion status.

Milestones:

Milestone 1: Publish Annual Comm Plan

Start Date: FY22Q1; **End Date:** FY22Q2

Milestone 2: Execute Annual Communication Plan

Army People Strategy: Military Implementation Plan 2.0

Start Date: FY22Q2; **End Date:** FY23Q1

Milestone 3: Assess Annual Communication Plan

Start Date: FY22Q1; **End Date:** FY22Q3

Milestone 4: Review results/identify lessons learned/areas for improvement

Start Date: FY23Q2; **End Date:** FY23Q2

Objective 8.19: Suicide Prevention Program Training and Education

From Resiliency LOE 3 – Resilience, Suicide Prevention Program, and Army Substance Abuse Program

OPR: ARD; **OCR:** ASA(M&RA), DCS G-1

Develop and implement progressive and complimentary training and education activities for Leaders, Soldiers, and response professionals to impart the knowledge, skills, and attitudes that enable increased advocacy and improved response.

Objective End State: Conditions, individual and collective, have been transformed, restored, or sustained to enable optimal resilience and performance.

Key Tasks:

Task 8.19.a: Implement Gatekeeper (Suicide Prevention) Training (Ask, Care, Escort (ACE))

OPR: ARD; **OCR:** ASA(M&RA), DCS G-1

Dependencies: None Identified.

Task Measures of Effectiveness and Performance:

None Identified. Defaults to Milestone completion status.

Milestones:

Milestone 1: Conduct Pilot Field test

Start Date: FY22Q2; **End Date:** FY22Q4

Milestone 2: Implement approved training (publish policy directive and implementation guidance)

Start Date: FY22Q4; **End Date:** FY23Q1

Milestone 3: Transition to monitoring and continuous improvement

Start Date: FY23Q1; **End Date:** FY25Q4

Task 8.19.b: Develop Time-Based Prevention: Lethal Means Safety Toolkit

OPR: ARD; **OCR:** ASA(M&RA), DCS G-1

Dependencies: None Identified.

Army People Strategy: Military Implementation Plan 2.0

Task Measures of Effectiveness and Performance:

None Identified. Defaults to Milestone completion status.

Milestones:

Milestone 1: Develop toolkit

Start Date: FY22Q2; **End Date:** FY22Q4

Milestone 2: Field pilot toolkit

Start Date: FY22Q4; **End Date:** FY23Q1

Milestone 3: Evaluate toolkit

Start Date: FY23Q2; **End Date:** FY23Q4

Milestone 4: Review results/identify lessons learned/areas of improvement

Start Date: FY23Q4; **End Date:** FY23Q4

Objective 8.20: Suicide Prevention Program Science and Research

From Resiliency LOE 3 – Resilience, Suicide Prevention Program, and Army Substance Abuse Program

OPR: ARD; **OCR:** ASA(M&RA), DCS G-1

Systematic, strategic, and actionable research plans that support targeted, evidence-based improvements to response processes, procedures, and policies.

Objective End State: Conditions, individual and collective, have been transformed, restored, or sustained to enable optimal resilience and performance.

Key Tasks:

Task 8.20.a: Plan and oversee research and disseminate findings/recs on response, other than topics covered in SHARP TAPS

OPR: ARD; **OCR:** ASA(M&RA), DCS G-1

Dependencies: None Identified.

Task Measures of Effectiveness and Performance:

None Identified. Defaults to Milestone completion status.

Milestones:

Milestone 1: Develop study plans and receive approvals for research on response

Start Date: FY23Q1; **End Date:** FY25Q4

Milestone 2: Conduct analyses for research on response

Start Date: FY23Q1; **End Date:** FY25Q4

Army People Strategy: Military Implementation Plan 2.0

Milestone 3: Publish final reports for research on response

Start Date: FY23Q1; **End Date:** FY25Q4

Objective 8.21: Army Substance Abuse Program Assessment and Evaluation

From Resiliency LOE 3 – Resilience, Suicide Prevention Program, and Army Substance Abuse Program

OPR: ARD; **OCR:** ASA(M&RA), DCS G-1

Assessment and evaluation framework is implemented, providing sufficient feedback to enable senior leader assessment of the effectiveness of the comprehensive response approach.

Objective End State: Conditions, individual and collective, have been transformed, restored, or sustained to enable optimal resilience and performance.

Key Tasks:

Task 8.21.a: Monitor Substance Abuse Prevention program (ADAPT)

OPR: ARD; **OCR:** ASA(M&RA), DCS G-1

Dependencies: None Identified.

Task Measures of Effectiveness and Performance:

None Identified. Defaults to Milestone completion status.

Milestones:

Milestone 1: Deliver evaluation report to IMCOM/ Determine recommendations for implementation

Start Date: FY22Q2; **End Date:** FY22Q2

Milestone 2: Develop action plan for short term evaluation

Start Date: FY22Q4; **End Date:** FY23Q1

Milestone 3: Field test/analyze results/publish implementation guidance

Start Date: FY22Q4; **End Date:** FY23Q1

Milestone 4: Monitor evaluation actions/update DAMIS for reporting

Start Date: FY23Q1; **End Date:** FY25Q4

Milestone 5: Brief results to leadership

Start Date: FY23Q1; **End Date:** FY23Q1

Milestone 6: Conduct QA/QC as part of SAV process

Start Date: FY22Q4; **End Date:** FY23Q1

Army People Strategy: Military Implementation Plan 2.0

Milestone 7: Utilize data to establish short/long term goals for the resource use and effectiveness

Start Date: FY22Q4; **End Date:** FY23Q1

Task 8.21.b: Determine benefit of conducting ADAPT

OPR: ARD; **OCR:** ASA(M&RA), DCS G-1

Dependencies: None Identified.

Task Measures of Effectiveness and Performance:

None Identified. Defaults to Milestone completion status.

Milestones:

Milestone 1: Monitor Soldiers who have attended to see their career success rate while retained to military service to include receiving honorable discharge

Start Date: FY23Q1; **End Date:** FY24Q1

Objective 8.22: Army Substance Abuse Program Strategic Communication and Outreach

From Resiliency LOE 3 – Resilience, Suicide Prevention Program, and Army Substance Abuse Program

OPR: ARD; **OCR:** ASA(M&RA), DCS G-1

Promote trust and confidence across the force and among the American public in the Army's ability to provide professional and compassionate care and support to Soldiers, DA Civilians, and Family members through a comprehensive response system.

Objective End State: Conditions, individual and collective, have been transformed, restored, or sustained to enable optimal resilience and performance.

Key Tasks:

Task 8.22.a: Communicate ADAPT/Prime For Life (PFL) to Commanders/1SGT for Soldier participation resulting from illegal substance or alcohol misconduct identification

OPR: ARD; **OCR:** ASA(M&RA), DCS G-1

Dependencies: None Identified.

Task Measures of Effectiveness and Performance:

None Identified. Defaults to Milestone completion status.

Milestones:

Milestone 1: ASAP representative ensures info regarding ADAPT, recommend course

Start Date: FY22Q1; **End Date:** FY22Q4

Milestone 2: Commanders ensure attendance and completion

Army People Strategy: Military Implementation Plan 2.0

Start Date: FY22Q1; **End Date:** FY22Q4



**Chapter 9: Sexual Harassment/Assault
Response and Prevention
Military Implementation Plan 2.0**

Army People Strategy: Military Implementation Plan 2.0

Sexual Harassment/Sexual Assault Response and Prevention

Introduction

Sexual assault, sexual harassment, and associated retaliatory behaviors degrade mission readiness, erode organizational trust and cohesion, and hurt the well-being of the Army's greatest resource, its people. Despite past periods of recorded progress, sexual assault and sexual harassment remain significant problems for military personnel. Every member of the Total Force deserves a workplace free of sexual assault, sexual harassment, and fear of retaliation. To support the Army People Strategy and achieve the goal of eliminating these harmful behaviors, the Army is taking deliberate and substantive action to address sexual assault and sexual harassment. The tasks and milestones outlined in this plan are critical to maintain momentum and build trust through demonstrable progress, clear and enduring implementation mechanisms, increased transparency, and continued senior leadership involvement.

Guided by the recommendations of the 90-day Independent Review Commission on Sexual Assault in the Military, the Army will undergo a series of major reforms in leader development and how reports of sexual assault and complaints of sexual harassment are actioned. These changes are aimed at improving care for victims, holding offenders accountable, and rebuilding trust between Soldiers and leadership. Major initiatives will comprehensively improve efforts at the installation level in response, take the initial steps to establish a violence prevention workforce, and initiate changes to the military justice process governing the handling of sexual assault and sexual harassment cases.

To truly take care of soldiers and re-establish a culture of trust within Army organizations, and the public, we must do more to eliminate sexual assault and sexual harassment from the ranks. There is no middle ground in the battle against sexual harassment and sexual assault. To fully succeed, the structural changes outlined in this implementation plan must be reinforced through leadership and embraced by all service members. We must weave the standards that create a climate of dignity and respect into the fabric of day-to-day operations.

Objective 9.1: Create Office of the Special Trial Counsel

(From SHARP LOE 1 - Accountability)

Resource the Military Justice System to successfully create a dedicated Office of the Special Trial Counsel to expertly and professionally litigate and make key decisions on covered offense crimes.

OPR: Office of the Judge Advocate General (OTJAG)

Objective End State: Military Justice Reform's successful transfer of key authorities to independent judge advocates on all cases involving murder, sexual assault, domestic violence, and other "covered offenses" while focusing on independence, the building of expertise, and preserving the Army's commitment to good order and discipline. As part of this reform, the creation of a military justice career model to cultivate and enhance the investigation and litigation of special victim crimes and the military justice enterprise as a whole.

Army People Strategy: Military Implementation Plan 2.0

Key Tasks:

Task 9.1.a: Establish the Offices of Special Victims Prosecutors

OPR: OTJAG Criminal Law Division; **Data Owner:** OTJAG

Establish the Offices of Special Victims Prosecutors and remove prosecution of sexual assaults and related crimes out of the military chain of command (IRC Recommendation 1.1).

Dependencies: None Identified.

Task Measures of Effectiveness and Performance:

Measures of Performance:

- Special Trial Counsel reviews every case involving a covered offense upon transfer of authority.

Milestones:

Milestone 1: Office of the Special Trial Counsel, Initial Operational Capability (IOC)

Start date: FY22Q4; **End date:** FY23Q4

Milestone 2: Nominate Lead Special Trial Counsel

Start date: FY22Q4; **End date:** FY23Q2 or when confirmed by Congress

Milestone 3: Special Trial Counsel PCS complete

Start date: FY23Q4; **End date:** FY23Q4

Milestone 4: Office of the Special Trial Counsel, Full Operational Capability (FOC), Full Transfer of Authorities

Start date: FY24Q1; **End date:** FY25Q4

Task 9.1.b: Professionalize career billets for military justice personnel handling special victim crimes

OPR: OTJAG Criminal Law Division; **Data Owner:** OTJAG

Professionalize career billets for military justice personnel handling special victim crimes. (IRC Recommendation 1.4).

Dependencies: None Identified.

Task Measures of Effectiveness and Performance:

Measures of Performance:

- Implementation of a Military Justice Career Model consisting of additional resourcing of enhanced military justice career billets and qualitative assessments to identify, develop, and employ career litigators.

Milestones:

Army People Strategy: Military Implementation Plan 2.0

Milestone 1: Initial Military Justice Career Model Implementation Plan

Start date: FY21Q4; **End date:** FY22Q1

Milestone 2: Military Justice Career Model Policy Guidance Issued

Start date: FY22Q3; **End date:** FY23Q4

Milestone 3: Full Implementation of Military Justice Career Model

Start date: FY23Q4; **End date:** FY25Q4

Objective 9.2: Optimize Victim Care and Support

(From SHARP LOE 3 – Victim Support and Services)

OPR: ARD SHARP Division; **OCR(s):** Army SHARP Academy, United States Army Manpower Analysis Agency (USAMAA)

Objective End State: SHARP personnel provide victims with compassionate, best-in-class care, support, and protection. Improved collaboration between military healthcare providers, civilian community-service providers, and other relevant personnel and organizations to ensure victims' needs are met and the rights and privacy of survivors are protected.

Key Tasks:

Task 9.2.a: Move Sexual Assault Response Coordinators (SARC) and Sexual Assault Prevention and Response Victim Advocates (SAPR VA) from the command reporting structure

OPR: SHARP Program Management Branch; **Data Owner:** Office of People Analytics

Move SARCs and SAPR VAs from the command reporting structure (IRC Recommendation 4.1 a).

Task End State: SHARP personnel provide victims with compassionate, best-in-class care, support, and protection. Improved collaboration between military healthcare providers, civilian community-service providers, and other relevant personnel and organizations to ensure victims' needs are met and the rights and privacy of survivors are protected

Dependencies: None Identified.

Task Measures of Effectiveness and Performance:

Measures of Performance:

- Percentage of installations complete with realignment of SARC/VA personnel.

Measures of Effectiveness:

- Command climate data collected through the administration of unit-level DEOCS surveys provides an assessment of the level of trust within an organization. Organizational climate is assessed using DoD established risk and protective factors.

Army People Strategy: Military Implementation Plan 2.0

Milestones:

Milestone 1: Develop COAs to move SARCs and VAs from the command reporting structure based on OSD guidance.

Start date: FY22Q1; **End date:** FY22Q2

Milestone 2: Conduct manning analysis to determine SHARP workforce capabilities and gaps.

Start date: FY22Q3; **End date:** FY24Q4

Milestone 3: Develop and disseminate communication strategy to leadership on the implementation standards for new model for the SHARP program.

Start date: FY22Q3; **End date:** FY23Q2

Milestone 4: Issue an Army Directive to implement the new reporting structure, programmatic oversight, and the elimination of collateral duty SARCs and VA phased approach.

Start date: FY22Q3; **End date:** FY23Q2

Milestone 5: Publish Army Regulation for SHARP program

Start date: FY22Q3; **End date:** FY23Q1

Milestone 6: Conduct TDA Change Management Plan (CMP) to realign existing SARC and VA requirements and authorizations.

Start date: FY22Q3; **End date:** FY24Q1

Milestone 7: SARC/VA Personnel Realignment.

Start date: FY23Q1; **End date:** FY24Q4

Task 9.2.b: Eliminate collateral duty for SARCs and VAs

OPR: ARD SHARP Division; **OCRs:** Army Sharp Academy, USAMAA; **Data Owner:** Office of People Analytics

Eliminate collateral duty for SARCs and VAs (IRC Recommendation 4.1 b).

Task End State: SHARP personnel provide victims with compassionate, best-in-class care, support, and protection. Improved collaboration between military healthcare providers, civilian community-service providers, and other relevant personnel and organizations to ensure victims' needs are met and the rights and privacy of survivors are protected.

Dependencies: Task 9.2.a: Move Sexual Assault Response Coordinators (SARC) and Sexual Assault Prevention and Response Victim Advocates (SAPR VA) from the command reporting structure

Task Measures of Effectiveness and Performance:

Measures of Performance:

- Percentage of units complete with the reduction of collateral duty SARC/VA positions.

Army People Strategy: Military Implementation Plan 2.0

Measures of Effectiveness:

- Command climate data collected through the administration of unit-level DEOCS surveys provides an assessment of the level of trust within an organization. Organizational climate is assessed using DoD established risk and protective factors.

Milestones:

Milestone 1: Conduct manpower study to determine manpower requirements of new SHARP workforce model.

Start date: FY22Q3; **End date:** FY24Q4

Milestone 2: Re-evaluate SHARP courses to fulfill the needs of a full-time workforce and new structure components.

Start date: FY24Q1; **End date:** FY25Q1

Milestone 3: Develop and execute a phased approach for the elimination of collateral duty SARCs and VAs.

Start date: FY22Q3; **End date:** FY24Q4

Milestone 4: Submit to OSD the Exceptions to Policy to retain collateral duty for specific types of environments throughout the Army.

Start date: FY23Q4; **End date:** FY24Q4

Task 9.2.c: Professionalize, strengthen, and resource the Sexual Assault Prevention and Response workforce

OPR: ARD SHARP Division; **OCRs:** Army Sharp Academy; **Data Owner:** Office of People Analytics

Professionalize, strengthen, and resource the Sexual Assault Prevention and Response workforce across the enterprise (IRC Recommendation CC 2).

Task End State: SHARP personnel provide victims with compassionate, best-in-class care, support, and protection. Improved collaboration between military healthcare providers, civilian community-service providers, and other relevant personnel and organizations to ensure victims' needs are met and the rights and privacy of survivors are protected.

Dependencies: None Identified.

Task Measures of Effectiveness and Performance:

Measures of Performance:

- Manning rates for military SHARP positions.

Milestones:

Milestone 1: Conduct manning analysis to determine resource requirements of new SHARP workforce model.

Start date: FY22Q3; **End date:** FY24Q4

Army People Strategy: Military Implementation Plan 2.0

Milestone 2: Execute a standardized plan to address self-care and well-being to prevention burnout within the SHARP workforce.

Start date: FY22Q3; **End date:** FY23Q4

Milestone 3: Conduct a study to examine options for a Military Occupational Specialty or Specialty Code for military personnel serving as a SARC or VA.

Start date: FY25Q1; **End date:** FY25Q4



**Chapter 10: Holistic Health & Fitness
Military Implementation Plan 2.0**

Army People Strategy: Military Implementation Plan 2.0

Holistic Health and Fitness

Lead integrator: TRADOC CIMT

Introduction: The Army recognizes that the Soldier must remain the most flexible and discriminately lethal force on the battlefield. Soldiers are the Army's most prized weapon system that will enable dominance in any conflict. Changes in the strategic and operational environments are outpacing current processes for physical and non-physical performance training, putting this dominance at risk. To accomplish any mission, we must significantly increase investment in how we understand, assess, and improve the holistic health and fitness of the Total Army.

While future challenges to American interests are unpredictable, we know Soldiers must maintain a ready and adaptive posture. To accomplish this, we require a comprehensive human performance optimization system for every Soldier, leveraging evidence-based information and best practices, to proactively improve personal readiness. The **Holistic Health and Fitness (H2F) System** is the Army's primary investment in Soldier readiness and lethality, optimal physical and non-physical performance, reduced injury rates, improved rehabilitation after injury, and increased overall effectiveness of the Total Army. The system empowers and equips Soldiers to take charge of their health, fitness, and well-being to optimize individual performance, while preventing injury and disease.

Highly trained, disciplined, and fit Soldiers build cohesive teams. Army teams are strongest when we ensure each individual Soldier's performance is optimized. To accomplish this, we are bringing a **cultural change** to Soldiers' perceptions of training for the demands of close combat. All Soldiers must view their health and fitness as a critical requirement for membership in the Profession of Arms.

The H2F System provides a unified and holistic vision with an effective implementation strategy to improve the Army's culture of health and fitness. The purpose of this document is to provide a conceptual foundation for continued discussion, analysis, and further development of the Army's H2F System.

Investing in health and fitness benefits Soldiers and their families. It also ensures the sustainment of an agile and adaptive Army, ready to provide the nation with a professional, lethal, and decisive force that will win against any adversary.

The nation faces one of the most complex global security environments since the end of the Cold War. Adapting in the face of uncertainty demands a new approach. In increasingly challenging environments, materiel solutions alone will not provide the decisive edge against the complex array of threats we face. General Mark A. Milley, the 39th Chief of Staff of the Army, noted "The capability and capacity of the Total Army on today's battlefield is threatened by **poor health and lack of physical readiness.**" To answer this challenge, the Army must invest in its most valuable resource: the Soldier.

Nested within the Department of Defense (DOD) Total Force Fitness (TFF) program and the *Army Campaign Plan*, Holistic Health and Fitness (H2F) is an enterprise-wide readiness "system" that combines all aspects of physical and non-physical human performance optimization under a single governance structure to enable

Army People Strategy: Military Implementation Plan 2.0

commanders to improve Soldier health and fitness. The H2F System encompasses both the physical and non-physical domains (mental readiness, sleep readiness, nutritional readiness, and spiritual readiness) required for optimal performance and improved readiness.

To win on the battlefield, Soldiers must first deploy to the battlefield. The H2F System focuses on improving health- and fitness-related knowledge, attitudes, and behaviors to increase deployable rates currently degraded by obesity, injury, and poor lifestyle choices. By addressing and optimizing mental wellness and acuity, this system builds agile, adaptable, and fit Soldiers. The H2F System provides education, coaching, mentoring, messaging, and outreach to improve, restore, and maintain the readiness, resilience, and performance of the Total Army. Immersing Soldiers throughout their Army careers in a new **Army Readiness Culture** allows them to win the nation's wars and return home healthy.

Holistic Health and Fitness provides commanders with a comprehensive, immersive, and integrated system that optimizes the physical and non-physical performance of their Soldiers and their units. Best practices, when applied to warfighter management and mission planning in tactical environments, bolster performance and enhance readiness. However, for the H2F System to be successful, engaged leaders must set a personal example and foster an environment conducive to changing the culture of health and fitness in the Army.

Strategic Objectives

The H2F System identifies four strategic objectives focused on building cohesive teams that are ready, professional, diverse, and integrated.

Strategic Objective #1: *Acquire Talent*. The Army achieves Strategic Objective #1 by marketing the H2F System within the marketplace to positively impact prospective recruits' attitudes towards Army service. The H2F Directorate, USACIMT, will continue to work closely with the Army Enterprise Marketing Office to develop clear and concise messaging highlighting the H2F System as the Army's primary investment into the health and well-being of its Soldiers.

Strategic Objective #2: *Develop Talent*. The Army achieves Strategic Objective #2 by integrating H2F principles into leader development programs of instruction, doctrine, and institutional training center standards, thus improving the leadership behaviors and competencies of officers, NCOs, and civilian leaders. This objective also incorporates training of H2F resourced brigades through the USACIMT, H2F Integration Team, and credentialing through the procedures established for H2F Performance Team professionals.

Strategic Objective #3: *Employ Talent*. The Army achieves Strategic Objective #3 by designing and supporting health and fitness programs that promote health and

Army People Strategy: Military Implementation Plan 2.0

performance optimization. Support to this objective will ensure the readiness of the individual Soldier and improve the Army's ability to employ its officers, warrant officers, noncommissioned officers, and Soldiers.

Strategic Objective #4: Retain Talent. The Army achieves Strategic Objective #4 through the H2F System by improving overall Soldier and unit morale and effectiveness by investing in health and fitness of Soldiers. These actions will allow us to retain talent with the requisite knowledge, skills, and behaviors critical to maintaining the readiness and lethality of the Army.

Key Tasks:

The following key tasks define outcomes necessary and relevant to achieve H2F strategic objectives:

Task 10.1.a: From FY21 through FY30, establish the H2F System across 110 Active Duty Brigades.

OPR: TRADOC CIMT

Major actions within this key task include: establish and maintain currency of H2F doctrine to support the implementation of the H2F System; continue on-boarding training of FY21 and beyond H2F resourced-brigades through the H2F Integration Team; publish needed updates to the DA EXORD (#149-19), "Establish the H2F System" that allows us to assess implementation and adjust aims as required. Establish outcomes/summative evaluation plan to assess short and long-term return on investment. Actions will continue to support implementation in the out-years to complement fielding through FY30.

Task 10.1.b: NLT FY24 Implement the Army Combat Fitness Test (ACFT).

OPR: TRADOC CIMT

On 1 APR 22 the ACFT became the Army's official physical fitness test. The H2F Directorate, USACIMT, will continue to support policy / doctrine updates, design reviews, and implementation associated with this decision.

Task 10.1.c: From FY22 until complete, incorporate H2F governance and curriculum in PME across all cohorts.

OPR: TRADOC CIMT

H2F education was added to the Basic Leader Course in FY22. We continue to make strides to implement H2F education into Basic Combat Training in FY22 and to also update the curriculum in the Basic Officer Leadership Course. Collaboration continues with NCOLCOE to institutionalize H2F education into all enlisted PME courses to develop and sustain engaged leaders who can lead, coach, teach, and mentor H2F tenets to enhance readiness and human performance.

Task 10.1.d: NLT end of FY23, award construction of Soldier Performance Readiness Centers (SPRC) at 10 H2F-resourced brigades.

OPR: TRADOC CIMT

Army People Strategy: Military Implementation Plan 2.0

SPRCs will serve as the unit owned, fixed facility where the H2F Performance Teams will operate from to impact the readiness of the individual Soldier. SPRC Standard designs and facility criteria have been developed and approved and we anticipate the fielding plan to be approved soon.

Task 10.1.e: NLT FY24 Establish the H2F Academy.

OPR: TRADOC CIMT

The H2F Academy serves as the bedrock institution for H2F capability development, H2F personnel proponency, institutional research, doctrine, and training development across the five H2F Domains. The H2F Academy provides resident and virtual onboarding of new H2F Performance Team personnel including military, Department of the Army Civilian, and contracted practitioners assigned to H2F Performance Teams. At end state, H2F Academy integrates like-competencies resident within existing Army organizations in an integrated approach to provide best-fit H2F capabilities across all Army components.

Task 10.1.f: NLT FY24, establish H2F Additional Skill Identifier and NLT FY26, establish H2F Trainer Military Occupational Specialty (MOS).

OPR: TRADOC CIMT

Historically, the U.S. Army has lagged behind other modern armies in providing trained and certified physical and non-physical training instructors for the Total Army. The intent of this key task is to develop an H2F Instructor MOS for the Army. This MOS is integral to the long-term viability of the H2F System and nests well with the Army's vision of "Soldier for Life." Professionally trained and educated Soldiers lead, reinforce, and sustain cultural change in the Army.

Task 10.1.g: NLT FY28 establish an H2F implementation plan across the Reserve Component.

OPR: TRADOC CIMT

To truly impact readiness, the H2F System has to encompass the Reserve Component. Ensuring that that there is predictable funding tied to an implementation plan allows this to occur.



**Chapter 11: People Analytics
Military Implementation Plan 2.0**

Army People Strategy: Military Implementation Plan 2.0

People Analytics

People Analytics (PA) is not simply gathering more raw data, nor is it compiling more descriptive statistics, employing AI, or benchmarking – it is providing causal analysis and evaluations of existing programs and policies to solve problems; help design, test, and implement new ones; identify opportunities for improvement in a variety of programs such as: recruiting, retention, diversity, equity and inclusion, and improvements to performance and others.

1. **Mission:** Use data as basis for decision-making. Use people and organization data, analysis, and sound research science techniques to understand, improve and optimize people side of the army.
2. **Collaborate** – identify, review, or propose changes to Army policy, regulations, or statutes to improve Soldier quality of life and civilian professional growth.
3. **Coordinate** – (People) Analytics Function business case, roadmap & use case prioritization for any request for support (quantitative, qualitative review, statistical report, surveys, and dashboard creation).
4. **Strategic Alignment** – includes policies, practices and culture governing people data and processes involving collection, extraction, cleaning, transformation, storage, protection, management, and administration. Army People Analytics Office shall, in support of SECARMY priorities, provide guidance in the implementation of people analytics data and measures; shall assist Army's insight projects on human capital/human dimension management efforts and move forward with the People Analytics developmental journey. People Analytics provides senior leaders with actionable, evidence- based insights that take the guesswork out of policy decisions in:
 - Identifying capabilities, strengths, weaknesses, gaps, and surpluses in Army Strategy execution.
 - Conducting enterprise level and command level diagnostics
 - Conducting workforce and process level diagnostics
 - Integrating the 4 "S" - Strategy, Systems, Statistics and Science through mixed methods (Army People Implementation Plan, January 2021, (approved).
 - Continuously assess, facilitate, and coordinate People Analytics implementation across the enterprise.
5. **Advocate funding** for human capital investment to meet People Analytics needs to support an MDO-capable force requirements at the individual, team, unit, and Army command levels.
6. **Evaluate and modify** – propose or set changes to Army policy, regulations, or statutes to improve Soldier quality of life and civilian professional growth.

Army People Strategy: Military Implementation Plan 2.0

Objective 11.1: Establish PA Integration Cell

(From People Analytics LOE 1 - Increase Analytical Capacity and Strategic Integration)

OPR: Army People Analytics Office

Establish PA Integration Cell to synchronize, facilitate and coordinate various siloed and disparate efforts in implementing Army People Strategy at the enterprise level.

Objective End State: Fully functional Army People Analytics Office.

The Army People Analytics Office (APAO) shall be fully functional to provide a focal point at the enterprise level, available to assist, synchronize and facilitate efforts on how to manage people analytics data effectively and use data to generate insight through the federated application of analytics.

Key Tasks:

Task 11.1.a: Outline Capabilities Needed for APAO to be Fully Functional

OPR: Army People Analytics Office

Outline what capabilities are needed against required capacity for the integration cell to deliver coordination and facilitation support to the Army enterprise for research, data analytics and survey resources.

Dependencies: Position descriptions, requirements established and approval from Front Office.

Task Measures of Effectiveness and Performance:

Measures of Performance:

- Collaboration and Coordination Model for PA is developed and approved

Measures of Effectiveness:

- Establishment of the PA Integration Cell (Army People Analytics Office) – operating model shall consist of:
 - Approval of Position Descriptions and Hiring Requirements are defined
 - Capabilities match position requirements
 - Time to Hire must not exceed 30 days
 - Onboarding Process executed
 - Collaboration and coordination roles and responsibilities are defined

Milestones:

Milestone 1: Recruitment requirements fulfilled

Start Date: FY22Q4; **End Date:** FY23Q2

Milestone 2: Hiring defined, initiated and onboarding completed

Start Date: FY23Q2; **End Date:** FY23Q4

Army People Strategy: Military Implementation Plan 2.0

Milestone 3: New Hire installed in APAO

Start Date: FY23Q4; **End Date:** FY23Q4

Objective 11.2: Federate Shared Analytics Service through PA Enterprise

(From People Analytics LOE 1 - Increase Analytical Capacity and Strategic Integration)

OPR: Army People Analytics Office

Federated shared analytics is the practice of applying data science methods to the analysis of raw data that is stored locally on users' devices. This works by running local computations over each device's data, displaying only aggregated results — and never any raw data from a particular device.

Federated analytics aims to support basic data science needs.

Objective End State: Increase the use of data in decision-making. Assure compliance with the planned federated and streamlined data analytics operations where data, regardless of source, is accessible and tools available to proponents for analysis.

Key Tasks:

Task 11.2.a: Data Access Policies

OPR: Army People Analytics Office

Ensure that policies requiring data access are reviewed and its impact assessed. People Analytics Cross-Functional Group (PA-CFG) shall continually review and update policies that unnecessarily restrict data sharing across the Army enterprise.

Dependencies: Data policies (enterprise) are available and accessible for review and analysis; concurrence/approval of Army Chief Information Officer or Chief Data Officer

Task Measures of Effectiveness and Performance:

Task Measures of Performance:

- Yearly increase in number of data management and administration policies reviewed and modified
- Number of business rules documented

Task Measures of Effectiveness:

- Increase in ability of user to extract data reports extract from various data sources
- Increase in quality of data analyses
- Identification of people data metrics that need modification.

Milestones:

Milestone 1: PA-CFG reviews and approves data policies that need amendments or modifications.

Army People Strategy: Military Implementation Plan 2.0

Start Date: FY22Q3; **End Date:** (indeterminate)

Milestone 2: APAO documents and proposes amendments to policies as proposed by PA-CFG.

Start Date: FY22Q3; **End Date:** (indeterminate)

Milestone 3: Approval from Chief Information Officer and/or Chief Data Officer on PA-CFG recommendations.

Start Date: FY22Q3; **End Date:** (indeterminate)

Task 11.2.b: People Analytics Data Catalog

OPR: Army People Analytics Office

PA-CFG shall identify and proposed a list of people analytics, create an authoritative data source (ADS) and data catalog.

Dependencies: PA-CFG shall identify what part of their system of record consists of people data; approval of Chief Information Officer and/or Chief Data Officer on PA-CFG recommendations.

Task Measures of Effectiveness and Performance:

Task Measures of Performance:

- Number of data profiles developed
- Yearly update of ADS, if needed
- Identification of system and list of people-data

Task Measures of Effectiveness:

- Increased consistency, transparency and completeness in exchange and use of people data by stakeholders, OPRs and decision makers.

Milestones:

Milestone 1: Identification of data that belong to People Domain

Start Date: FY23Q1; **End Date:** FY23Q4

Milestone 2: Creation of ADS, approval by PA-CFG

Start Date: FY22Q3; **End Date:** FY23Q4

Task 11.2.c: Proposed People Data Uses

OPR: Army People Analytics Office

APAO shall propose effective use of people data that drive aspects of enterprise metrics or human dimension data.

Army People Strategy: Military Implementation Plan 2.0

Dependencies: Identification of current and future enterprise metrics for human dimension and/or people analytics; timely review and approval by PA-Cross Functional Group (PA-CFG).

Task Measures of Effectiveness and Performance:

Task Measures of Performance:

- Initial document on Enterprise People Analytics/Human Dimension Data and Its Effective Use.
- Modifications to document as required

Task Measures of Effectiveness:

- Improved understanding of difference between HR metrics and people analytics.

Milestones:

Milestone 1: Initial documentation of Enterprise People Analytics/Human Dimension Data and its effective use

Start Date: FY22Q4; **End Date:** FY23Q2

Milestone 2: Approval by PA-CFG of Enterprise People Analytics/Human Dimension Data and its effective use

Start Date: FY23Q2; **End Date:** (Indeterminate)

Task 11.2.d: Define PA analytics business intelligence

OPR: Army People Analytics Office

Define PA analytics business intelligence boundary, dependencies, and state of data quality. Define what constitutes the PA domain (Human Capital and Human Dimension) analytic business intelligence.

Dependencies: Availability and accessibility of current Army system environment documentation or schematic of army system environment overview.

Task Measures of Effectiveness and Performance:

Measures of Performance:

- Yearly updates to current system environment documentation (as needed)
- Emails
- Number of collaborative meetings with data and system owners and stakeholders

Measures of Effectiveness:

- Increased ability to run any app on any cloud from any device to increase mission agility and speed up digital capabilities

Army People Strategy: Military Implementation Plan 2.0

- Ability to respond quickly to evolving end user requirements from any device and across platforms (on premises, cloud, or edge environments)
- Transparency, data consistency, compatibility, and data integrity
- Increase in Information Technology People Analytics resiliency

Milestones:

Milestone 1: Schematic document of Current Army System Overview

Start Date: FY23Q4; **End Date:** FY24Q4

Objective 11.3: Establish PA Research Forum, the People Analytics Cross Functional Group and communicate APAO and PA-CFG Strategic Functions and Priorities

(From People Analytics Implementation Plan, approved January 2021, LOE 2 – Improve Lateral Capability by establishing a research forum.)

OPR: Army People Analytics Office

Lateral capability is defined as “information and decision processes that coordinate activities spread out across different organizational units.”

Objective End State: Provide a forum or opportunity for collaboration and a more effective synergy between offices of primary responsibilities.

Key Tasks:

Task 11.3.a: Strategy Gaps and Overlaps

OPR: Army People Analytics Office

Identify gaps and overlaps between the various Army strategies where integration or opportunities for collaboration exists.

The strategies considered are: Army Strategy, Army People Strategy, Army Modernization Strategy, Army Talent Management Strategy, Army Digital Transformation Strategy, and Army Integrated Prevention Strategy.

Dependencies: Availability of strategic documents for review; approval by senior leaders to integrate some areas of the strategies where there are opportunities for integration (gaps and overlaps).

Task Measures of Effectiveness and Performance:

Measures of Performance:

- Mitigation Plan: How to mitigate Gaps and Overlaps Identified between Strategic Plans

Measures of Effectiveness:

- Reduces cost incurred due to reduction of duplicative churn

Milestones:

Army People Strategy: Military Implementation Plan 2.0

Milestone 1: APAO reviews changes to current strategies and assesses impact

Start Date: FY22Q3; **End Date:** (indeterminate)

Milestone 2: Identification of gaps, surpluses, and analyses of risks (ad hoc)

Start Date: FY22 ongoing; **End Date:** (indeterminate)

Objective 11.4: Funding Advocacy Board Integration

OPR: Army People Analytics Office

Army People Analytics Office shall integrate PA-CFG into funding advocacy boards.

Objective End State: Lobbying or advocacy is a way to get things done; Include PA-CFG in funding board to ensure that PA's mission in increasing Army readiness is provided for.

Key Tasks:

Task 11.4.a: Integrate PA-CFG into Funding Advocacy Boards (PA Director)

OPR: Army People Analytics Office

Dependencies: None Identified.

Task Measures of Effectiveness and Performance:

Task Measures of Performance:

- Attendance in meetings with decision makers and law makers together with organization staff.
- Increased demonstration of achievements
- Active participation in senior leaders or executive meetings.

Task Measures of Effectiveness:

- Increased PA visibility within the enterprise
- Increased use of PA metrics and analytics as performance and effectiveness measures across the enterprise

Milestones:

None Identified.

Task 11.4.b: Track requests and control requests for resource allocation/funding

OPR: Army People Analytics Office

Army People Analytics Office shall track report all requests for resources, technical or research and survey support, across PA domain more effectively and collaboratively, thereby reducing overall churn and costs.

Dependencies: None Identified.

Army People Strategy: Military Implementation Plan 2.0

Task Measures of Effectiveness and Performance:

Task Measures of Performance:

- Identification of available funds each fiscal year (>FY22 onwards)
- Identification of unallocated or unexpended funds from previous years (<current FY)
- Greater participation in funding prioritization and approval process
- Identification of current and future PA initiatives/activities
- Associating any proposed costs to Army mission and objectives

Task Measures of Effectiveness:

- Demonstrated return on investments
- Cost Benefit analysis
- Percentage - Reducing overall churn
- Targeted activities and initiatives are funded appropriately

Milestones:

Milestone 1: Submission of Yearly POM

Start Date: FY23Q1; **End Date:** FY25Q4

Milestone 2: Budget appropriated and allocated for PA resource needs

Start Date: FY23Q1; **End Date:** FY25Q4

Objective 11.5: Integrate PA-CFG into APS Governance

(From People Analytics LOE 3 - Increase Vertical Capability through PA-CFG)

OPR: Army People Analytics Office - East

Improved integration into APS governance will improve coordination with research partners to identify needed studies. Improved integration of the PA-CFG into resourcing processes will enable the APAO to better compete for funding to execute those requirements.

Objective End State: A fully integrated PA-CFG into the APS governance structure with sufficient resources to fund Internal Unit, research, data, and survey initiatives for the Army and ensures greater participation from PA-CFG members in prioritization of resources.

Key Tasks:

Task 11.5.a: Resource Qualitative People Analytics Research

OPR: Army People Analytics Office; **OCR:** RFL, ARI, ARD, CAPL, other research partners

Compete for sufficient resources so qualitative People Analytics research can be conducted. Qualitative research involves in-depth data using methods such as case studies, focus groups, and interviews and then analyzing them to gain insight into experiences, events, and opinions.

Army People Strategy: Military Implementation Plan 2.0

Dependencies: None Identified.

Task Measures of Effectiveness and Performance:

Task Measures of Performance:

- Number of research documents completed
- Insights used to supplement U.S. Army knowledge or contribute to the continuum of analytics
- Progress Reports

Task Measures of Effectiveness:

- Number of research recommendations/findings incorporated into U.S. Army operations/policy

Milestones:

Milestone 1: Research topics proposed and approved by PA-CFG

Start Date: FY22Q4; **End Date:** (indeterminate)

Objective 11.6: Improve analytics infrastructure

(From People Analytics LOE 4 – Develop Analytics infrastructure for APAO)

OPR: Army People Analytics Office

Improve analytics infrastructure to leverage data from current and future systems through analyses and automated query building facility and encourage greater use of data-centric methods and processes for decision-making.

Analytics infrastructure refers to services, applications, utilities, and systems that are used for either preparing data for modeling, estimating models, validating models, scoring data, or related activities. The concept is an umbrella term for a variety of technical layers that allow organizations to more effectively collect, organize, and parse the multiple data streams they utilize.

Objective End State: Linkage of data with business objectives for efficient tracking of performance, which broadcasted to an executive decision-making body through dashboards and share-point.

Key Tasks:

Task 11.6.a: Integration of data from disparate sources

OPR: Army People Analytics Office East and West

To create business intelligence by bridging the gap between organization current status against its desired end state/position through the integration of data from disparate data sources which includes but not limited to: IPPS-A, Advana and Avana.

Dependencies: None Identified.

Task Measures of Effectiveness and Performance:

Army People Strategy: Military Implementation Plan 2.0

Task Measures of Performance:

- Robust automated queries
- Dashboards and reports
- Facilitation and coordination meetings
- Technical notes and status reports to senior leaders
- Issues and Risk Mitigation Statements to senior leaders

Task Measures of Effectiveness:

- Correct information for any decision-making process.
- Awareness of issues and resolutions through active tracking
- Knowledge transfer between siloed and disparate systems in a common environment

Milestones:

Milestone 1: Executive Summary

Start Date: FY24Q1; **End Date:** FY24Q1

Task 11.6.b: Conduct People Analytics surveys

OPR: Army People Analytics Office – East and West

Conduct surveys which involves standardized data collection methods and a selection of a sample group. The survey will be used to generate statistically sound population estimates on key attributes, attitudes, opinions, and behaviors of interest, such as Soldier/DA Civilian's quality of life, military propensity, readiness, accession, and retention intentions.

Dependencies: Requests to conduct surveys reviewed and approved by APAO

Task Measures of Effectiveness and Performance:

Task Measures of Performance:

- Yearly Increase in Number of surveys

Task Measures of Effectiveness:

- Number of survey recommendations/findings incorporated into U.S. Army operations/policy

Milestones:

Milestone 1: Survey development (discovery, validation, integration, and assessment of findings)

Start Date: FY23Q1; **End Date:** FY25Q4

Task 11.6.c: Conduct explanatory/exploratory modelling

OPR: Army People Analytics Office – East and West

Army People Strategy: Military Implementation Plan 2.0

Conduct explanatory modelling by using techniques such as regression and structural equations to test theories or to better understand complex data patterns (observed vs unobserved variables.)

Dependencies: None Identified.

Task Measures of Effectiveness and Performance:

Task Measures of Performance:

- Number of theories tested
- Number of data models developed validated

Task Measures of Effectiveness:

- Results in effective design of search or sampling strategies that support senior leaders' decisions or provide sufficient basis to create valid conclusions or reliable insights based on a limited number of computational experiments.
- Determination of data quality maturity assessment

Milestones:

Milestone 1: Explanatory Data Models created and validated

Start Date: FY23Q1; **End Date:** FY25Q4

Objective 11.7: Improve Analytics Infrastructure

(From People Analytics LOE 5- Synchronize Various People Analytics Activities)

OPR: Army People Analytics Office

Foster an opportunity to define, align and advance the people enterprise programs and processes with the current force's needs, as well as those of a future MDO-capable Army.

Objective End State: Strategic alignment of HRC-Innovation Cell with activities of People Analytics Cross Functional Group and Army People Analytics Office.

Key Tasks:

Task 11.7.a: Collaboration with HRC Innovation Cell

OPR: APAO

Army People Analytics Office shall collaborate, synchronize, and utilize HRC Innovation cell, essentially a people focused unit, to work on the Army's effort to update legacy systems.

Dependencies: APAO (through HRC Innovation Cell) shall ensure that considerations, processes, and systems must precisely match individual Soldiers to prioritized Regionally Aligned Readiness and Modernization Model (ReARMM) ahead of manning

Army People Strategy: Military Implementation Plan 2.0

processes. Resources are available and allocated to identifying requirements in advance by Army People Analytics Office through PA Cross Functional Group.

Task Measures of Performance:

- Robust automated queries
- Dashboards and reports
- Facilitation and coordination meetings
- Technical notes and status reports to senior leaders
- Issues and Risk Mitigation Statements to senior leaders

Task Measures of Effectiveness:

- Correct information for any decision-making process
- Awareness of issues and resolutions through active tracking
- Knowledge transfer between siloed and disparate systems in a common environment

Milestones:

None Identified.

Task 11.7.b: Strategic Guidance and Framework

OPR: APAO

APAO shall provide guidance and direct HRC-Innovation Cell on strategy and framework on how people analytics enterprise will meet prioritized requirements for Army to agilely adapt to national defense planning and guidance.

Dependencies: APAO (through HRC Innovation Cell) shall ensure that considerations, processes, and systems must precisely match individual Soldiers to prioritized Regionally Aligned Readiness and Modernization Model (ReARMM requirements) ahead of manning processes. Resources are available and allocated to identifying requirements in advance by Army People Analytics Office through PA Cross Functional Group.

Task Measures of Performance:

- Requirement Elicitation document
- Legacy Systems Upgrades Requirements document
- Migration Plan
- Future System Requirements
- Facilitation and coordination meetings
- Technical notes and status reports to senior leaders

Task Measures of Effectiveness:

Army People Strategy: Military Implementation Plan 2.0

- Return on Investments
- Risks and Mitigation Measures Addressed
- Benefits of Upgrades

Milestones:

None Identified.



**Chapter 12: Institutionalize Talent
Management
Military Implementation Plan 2.0**

Army People Strategy: Military Implementation Plan 2.0

Institutionalize Talent Management

Transition Talent Management Task Force

Lead integrator: HQDA, DCS G-1

One of the critical enablers identified in the APS is twenty-first century Talent Management. The Army Talent Management Task Force (ATMTF) was created to serve as the Army's talent management innovation arm to continuously assess, study, and implement Talent Management initiatives and principles to improve the way the Army acquires, develops, employs, and retains talent. As the ATMTF evolves into a permanent organization, it continues to provide Army with strategic talent management innovation efforts that allow the Total Force to compete for and manage talent within a twenty-first century Talent Management System. For further details, see HQDA EXORD 227-22 ISO Army Talent Management Initiative Transition Implementation.

Use Data to Drive Talent Management

Chapter 5: Employ Talent is very Talent Management focused and contains several tasks to generate and use data for purposes of Talent Management. In particular, **Task 5.1.d: Army Talent Attribute Framework** sets out to create a common lexicon to facilitate automation systems and information sharing; and **Task 5.2.a: Talent Based Branching (TBB)**, **Task 5.2.b: Army Talent Alignment Process (ATAP)**, and **Task 5.2.c: Talent Based Career Alignment** all develop new and maturing capabilities to expand use of data to align talent.

Task 6.1.a: Department of the Army Career Engagement Survey (DACES) and **Task 6.1.b: Retention Prediction Model-A** also address collection and use of data in a Talent Management sense, from the perspective of retention of talent.

Chapter 11: People Analytics addresses in detail many planned advancements in collection and use of People-centric data for various purposes, one of the most prominent of which is Talent Management.

Build Assessments Ecosystem

The core talent management elements of the Army People Strategy and its annexes rely heavily on having data to understand and optimally use the talents of the force. A robust ecosystem of assessments is critical to supporting this intensive data requirement. The initial years of effort implementing the APS have resulted in several new assessments within the career lifecycle. Additional efforts are required to ensure the Army will have the robust, integrated assessment ecosystem required for modernized talent management.

Structuring the Ecosystem

Task 5.1.b: Talent Assessments Strategy (TAS) will establish a guiding framework for what talents and KSBs need to be assessed, when in the career lifecycle they need to be assessed, and how they will be assessed to support the personnel decisions of Soldiers and the Army.

Army People Strategy: Military Implementation Plan 2.0

Task 5.1.d: Army Talent Attribute Framework will institutionalize the language of KSBs across the Army to ensure that assessment data can be linked for each individual across their career, and to enable the Army to maximize the usefulness of assessment data to maintain strategic visibility of the workforce.

Populating the Ecosystem with Assessments

Task 3.2.f: Validate Officer Assessments will build and validate cognitive and non-cognitive assessments for the officer cohort in early stages of the career lifecycle. These may be integrated into the Talent Assessment Battery (TAB) which is used to support Talent Based Branching (Task 5.2.a) or the Officer Aptitude Battery (OAB) to support career alignment decisions later in the lifecycle.

Task 4.2.a: Enhance Leader Effectiveness Through Assessments will field assessments for the operational force to improve unit leadership effectiveness.

Task 5.1.a: Command Assessment Program (CAP) and Task 5.1.c: First Sergeant Talent Alignment Assessment (TAA) [Previously known as: Senior Noncommissioned Officer Assessment Program (SNAP)] institutionalize assessments to support identifying quality leaders for key command and leadership positions in the operational force.

Additional assessments required within the Assessment Ecosystem will be identified through the execution of Task 5.1.b: Talent Assessments Strategy (TAS). The development, validation, and implementation of these assessments will be incorporated as tasks in future iterations of this Military Implementation Plan.

Assessment Data Use and Protection

Intrinsic to the Assessment Ecosystem is the utilization of talent data collected through assessments. Chapter 11: People Analytics addresses in detail many planned advancements in collection and use of People-centric data to include assessments and the technological infrastructure and personnel competencies required to do so. The policies, practices, and infrastructure necessary to fully utilize and protect talent data derived from the assessments in the ecosystem are critical to ensuring the viability and long-term usefulness of the assessment ecosystem.

Task 11.2.a: Data Access Policies will develop, implement, and maintain policies to ensure that the Army can sustain the trust and confidence of the individuals in the workforce that their assessment data is protected from misuse and inappropriate exposure.

Support DEI Initiatives

DEI and associated initiatives are captured in Chapter 7: Advance Diversity, Equity, Inclusion, and Accessibility.

Army People Strategy: Military Implementation Plan 2.0

Optimize Human Resources Command

Task 12.1.a: HRC 2030 Restructure

OPR: HRC; **OCR:** HQDA, DCS G-1; **Data Owner:** N/A

Human Resources Command (HRC) 2030 will reorganize the structure of the command and leverage new information technologies like the Integrated Personnel and Pay System Army (IPPS-A) to provide senior leaders data-informed visualization tools and enable rapid decision-making. HRC will then be postured to conduct data-driven human resources services and is undertaking a reorganization to deliver modern and agile human resources services for Army 2030. To date, HRC has established a G6 and Enterprise Modernization directorate in FY22Q3 transforming its military human resources and technological data management processes. Reorganization planning will continue through FY22 and 23 with structure being documented in Total Army Analysis (TAA) products beginning FY 22Q4.

Task End State: HRC continues to deliver world-class talent management and Human Resources services to the Total Army. Additionally, HRC is postured to provide modern and agile human resources services to support the Total Army 2030 and beyond in multi-domain operations.

Dependencies: None Identified.

Task Measures of Effectiveness and Performance:

- Greater than 90% of proposed TDA changes are accepted through DA G-3 Force Management and documented in TAA 25-29
- Annual increase in assignment satisfaction following both enlisted and officer market execution beginning in FY24 as measured through post-market after action reviews

Milestones:

Milestone 1: Support implementation of IPPS-A Release 3 and beyond.

Start Date: FY23Q1; **End Date:** Ongoing

Milestone 2: Plan and develop HRC 2030 directorate structure and competencies; establish directorate initial operational capacity conditions; establish directorate fully operational capacity conditions.

Start Date: FY22Q2; **End Date:** FY24Q4

Milestone 3: Submission of Total Army Analysis Command Plan products to document accepted changes into future TDAs.

Start Date: FY23Q1; **End Date:** FY25Q1



**Chapter 13: Modernize and Sustain the
Army Workforce
Military Implementation Plan 2.0**

Army People Strategy: Military Implementation Plan 2.0

Modernize and Sustain the Army Workforce

Regaining Dominance in the Arctic

Lead integrator: DCS G-3

Introduction: The United States is an Arctic nation. As such, the Arctic security environment contributes directly to homeland defense and is of vital importance to national interests. In 2019, the Department of Defense (DoD) published its most recent Arctic Strategy with the objective of an Arctic that “is a secure and stable region in which U.S. national interests are safeguarded, the U.S. homeland is defended, and nations work cooperatively to address shared challenges.”

The DOD directs the Department to defend the homeland, compete to maintain favorable regional balances of power, and ensure common domains remain free and open. This Army strategy builds on those objectives to identify the ways the Army will ensure land dominance and continue to complete its missions as part of the Joint Force. To do this, the Army must understand the Arctic’s role in defending the homeland, the complicated geopolitical landscape within the context of great power competition, and how accelerated environmental change impacts future operations. With this understanding, the Army will be able to generate, project, and employ forces able to operate and compete in the Arctic as part of the joint force in support of Combatant Commands and in concert with allies and partners.

Regaining dominance in the Arctic provides new opportunities to engage and train with the many allies and partners around the world who also operate in extreme cold weather, mountainous, and high-altitude environments. The *Regaining Arctic Dominance, The U.S. Army in The Arctic*, Chief of Staff Paper #3, 19 January 2021, communicates the Army’s objectives and plan to build an Army capable of Multi-Domain Operations and regaining Arctic dominance.

Objective 13.1: Field Arctic-Capable Forces

OPR: TRADOC; **OCR:** DCS G-3

The Arctic environment calls for the generation of Arctic-capable units. In this strategy, Arctic-capable units are defined as those: enabled by doctrine, trained at echelon, with the right equipment, and manned by Soldiers with the appropriate knowledge, skills, and abilities to successfully operate in the Arctic. These formations could be employed in other sub-arctic, Extreme Cold Weather (ECW) and mountainous environments anywhere in the world. The Army currently has some resources to train Arctic-capable Soldiers and small units.

The ability to conduct effective and extended operations in the Arctic requires far more than just a set of specialized equipment. Units cannot simply be re-purposed or provide add-on capability to be proficient and survive arctic conditions.

Objective End State: The end state for the Training Arctic-Capable Forces objective is the U.S. Army can rapidly generate and project Multi-Domain forces globally that are

Army People Strategy: Military Implementation Plan 2.0

specifically trained, equipped, and sustained to fight, win, and survive in extreme cold weather and rugged mountainous conditions over extended periods.

Measures of Effectiveness and Performance:

- Train unit leaders and individual Soldiers to conduct small unit operations in cold, snow-covered environments (goal: **increase**) (Source: G-3)
- Train special operations Soldiers to survive and fight in mountainous environments (goal: **increase**) (Source: G-3)
- Project power from, within, and into the Arctic to conduct and sustain extended operations in competition, crisis, and conflict from a position of advantage (goal: **increase**) (Source: G-3)
- Employ calibrated force posture and multi-domain formations to defend the homeland and pose dilemmas for great power competitors. (goal: **increase**) (Source: G-3)
- Engage with and strengthen allies and partners to maintain regional stability. (goal: **increase**) (Source: G-3)

Key Tasks:

While the strategy to regain Arctic dominance is inclusive of all staff and commands across the Army, the tasks below focus on developing people to work in such an environment. Other tasks can be found in the original strategy paper.

Task 13.1.a: Implement talent management efforts to make best use of Soldiers at all echelons trained in Arctic operations

OPR: DCS G-1; **OCR:** DCS G-3

Operations in the Arctic are atypical from those experienced in more temperate climates Soldiers are accustomed to. Currently, graduates of the AMWS receive the Special Qualification Identifier for Military Mountaineering, which identifies them for future assignments for mountain units and duty locations. A similar identifier for Arctic training, denoting the skills of graduates of Arctic and ECW training programs, would allow for unit commanders and human resource managers to select Soldiers best suited for the unique requirements of Arctic-capable organizations in the Army Talent Management Process.

Task End State: The Army can respond to crisis without maintaining an array of environmental-specialized units.

Milestones:

None Identified.

Implementing the Army Digital Transformation Strategy (ADTS)

Lead integrator: Office of the Chief Information Officer (CIO)

Introduction: As the Army marches toward its goals of being a more ready, lethal, and modern force by 2030, it faces unprecedented challenges in modernizing its platforms

Army People Strategy: Military Implementation Plan 2.0

and weapons systems, but also its business processes and workforce to dominate adversaries on and off the battlefield in multi-domain operations (MDO).

The Army Digital Transformation Strategy (ADTS), established by the Office of the CIO, is the overarching framework that will set the vision, establish lines of effort (LOE), and implement strategic digital transformation initiatives prioritized and resourced as required to achieve this end state. Each LOE and initiative must be outcome driven to ensure that it is operationally effective in a resource constrained future.

The Army must and will make bold investments in transformative digital technologies, build the workforce into one with the training and experience to execute the full range of Army missions in increasingly complex technological environments, and put the right data in decision makers' hands quicker than ever before.

The Office of the CIO will lead these efforts for the Army in partnership with Headquarters, Department of Army (HQDA), Army Commands, Army Service Component Commands (ASCCs), Direct Report Units (DRUs), the DoD CIO and Joint Staff, and Allied Nation Partners as required.

Objective 13.2: Implement the ADTS

OPR: Office of the CIO; **OCR:** DCS G-6

As the Army responds to the growing need for digital technologies through Army modernization programs, the cybersecurity attack surface area is growing exponentially, and the dynamic threat environment requires the Army to make fundamental changes to address security in all phases of the lifecycle to ensure the Army is poised for defensive and offensive cyber operations. The Army must adapt a data-driven mindset and embrace digital transformation to successfully respond to the threat of great power competition and win decisively in a Large-Scale Combat Operations through MDO.

The Army Modernization Strategy identifies digital transformation as the means to modernize the Army to achieve the Army of 2030.

Objective End State: The end state is when digital transformation requires an outcomes-based, metrics-driven mindset to measure activities and to continually seek efficiencies and effectiveness.

Key Tasks:

The ADTS fully aligns with wider Army, and DoD modernization strategies, which share the vision of a more ready, lethal, and modern force by 2030. While inputs were taken from an extensive list of documents, several key strategies provided significant direction for the ADTS and influenced the objectives, LOEs, and overall priorities outlined. ADTS objectives are organized to indicate their alignment with Army's strategic pillars: modernization and readiness, reform, people, and partnerships. While only the people-impacted LOEs and objectives are covered below, all objectives and tasks can be found in the original ADTS paper.

Army People Strategy: Military Implementation Plan 2.0

Objective 13.3: Digital Workforce

OPR: Office of the CIO; **OCR:** HQDA, DCS G-6

The Army's people and its relationships with allied partners are vital to achieving the goal to dominate in MDO. In today's digital transformation revolution, simply having the newest technology is not sufficient – the Army needs the right digital skills to optimize, adapt, and fully apply the technology through innovation. Similarly, simply having strong partner relationships is not enough – the Army needs proper channels, networks, and systems in place to effectively collaborate and communicate. The Army workforce must understand, develop, apply, and enable digital priorities as well as external opportunities to improve collaboration with allies, academia, and industry.

The goal is to embrace the recognition that people drive Army's success on and off the battlefield. Robust recruiting and selection, training programs, digital career models, and partnerships with academia and industry will build a digital ready, adaptive, and innovative workforce, with the full range of required digital skills. In addition, sustained communications and interoperability with allied nations will ensure the Army optimizes its ability to collaborate in all domains. The following LOEs will drive the Army's ability to achieve its desired end state as a digital workforce with a network of valuable partners.

Objective End State: The Army has a tech savvy, operationally effective digital workforce partnered with a robust network of allies, industry, and academia.

Dependencies: None Identified.

Key Tasks:

Task 13.3.a: Build and deploy an organic digital workforce with mission critical skillsets by establishing partnerships with industry and academia (from ADTS Objective 3).

OPR: Office of the CIO; **OCR:** HQDA, DCS G-6

The Army workforce must acquire the necessary skillsets to effectively embrace and apply digital technology. The Army has initiated several pathfinders and initiatives to address how the Army will hire, retain, train, and deploy the digital workforce of the future. The Army must scale and expand the scope of each pathfinder.

Milestones:

None Identified.

Task 13.3.b: Identify and cultivate the skills needed by the Army of 2030 by fostering digital innovation and continuous learning (from ADTS Objective 3).

OPR: Office of the CIO; **OCR:** DCS G-6

The Army must identify and cultivate necessary skills by fostering innovation and continuous learning for the workforce to keep pace with changing technology. The Army must establish training for both civilians and military beyond traditional IT and include

Army People Strategy: Military Implementation Plan 2.0

how digital technologies can be adopted, implemented, and adapted across the Army thereby leading to heavy contractor reliance. The Army must establish robust recruitment and selection, training programs, development opportunities, new workforce models, and strategies to attract, develop, and retain top talent.

The Army will seek new authorities to more fully employ the digital talent across the active, reserve, and civilian components of the workforce to support any project in the Army at the time of need. New collaboration platforms for crowdsourcing will enable the remote workforce in concert with these new authorities to execute digital projects across the Army based on their skillsets so they are not limited to opportunities within their unit. The Army will utilize communities of interest to connect its digital workforce and facilitate technical discussions

Milestones:

None Identified.

Invest in Science and Technology Resources

Objective 13.4: Invest Appropriate Science and Technology Resources

OPR: DCS G-1; **OCR:** Assistant Secretary of the Army for Acquisition, Logistics, and Technology (ASA(ALT))

The core elements (Acquire, Develop, Employ, Retain) of the APS contain numerous specified and implied tasks that implicate Science and Technology (S&T) activities. S&T investment allows the Army to innovate and create new methods and processes to address the toughest challenges inherent in the desired outcomes of the APS, which cannot be accomplished solely through reliance on known or previously used approaches. S&T activities are resourced through the Research, Development, Test, and Evaluation (RDTE) planning, programming, budget, and execution (PPBE) processes under the oversight and direction of the Assistant Secretary of the Army (Acquisition Logistics & Technology), with input from Army Futures Command (AFC). While resourcing decisions regarding S&T to modernize talent management and the Army workforce reside with ASA(ALT) and AFC, the DCS G-1 is responsible for providing behavioral and social science research to support the strategic management of human capital and talent. The DCS G-1, ASA(M&RA), and TRADOC are involved in defining the S&T requirements, and typically are the operational end users or partners receiving the S&T products. In sum, multiple Army organizations control, direct, and influence APS-relevant S&T through a variety of mechanisms. Active engagement between the personnel focused organizations of the Army and the modernization focused organizations is required to ensure appropriate S&T resources are allocated to support the talent management and workforce modernization efforts described in the APS 2030.

Ongoing S&T activities in support of the core elements of the APS include: 1) new methods to identify talent and job requirements; 2) innovative assessment approaches to acquire, employ, and retain high potential Soldiers; 3) methods and models to inform

Army People Strategy: Military Implementation Plan 2.0

leader development, career management, and career paths; and 4) methods and measures to bridge the gap between talent management at the individual, team, and enterprise levels. While current S&T activities encompass a broad swath of topic areas, objectives within the core APS elements remain without substantive S&T support, including portions of the Develop (e.g., coaching, credentialing), Employ (e.g., career-pathing), and Retain (e.g., compensating, transitioning) core elements.

Additionally, several key objectives in the MIP Strategic Approach (Figure 1) in the Efforts on “Care for Soldiers, DA Civilians, and Families,” “Institutionalize Talent Management,” and “Modernizing and Sustain the Army Workforce” do not yet have appropriate S&T resourcing. These include research support for building positive command climates and preventing harmful behaviors, building an assessment ecosystem, DEIA initiatives, building the digital/data workforce, advancing the Arctic force, and adapting recruiting and retention for the modern U.S. labor market.

Furthermore, while some of these objectives have had S&T support to date, the existing R&D support focused on resilience and harmful behaviors has been primarily executed by the Medical Research and Development Command (MRDC), which will realign to the Defense Health Agency on 30 September 2022. This will leave the majority of the “Care for Soldiers, DA Civilians, and Families” without S&T resources to support its key objectives.

Objective End State: The end state is that the Army can identify its S&T funding and resourcing needs, tie them to the requirements of ongoing and upcoming programs in the People space, and identify any gaps that induce program risk. One of the central pillars for modernizing the workforce is acquiring and investing the appropriate S&T resources – manpower and funding – to build a diverse, cohesive, and disciplined all-volunteer force in sufficient numbers and with the relevant KSBs to dominate near peer adversaries on the modernized battlefield. Workforce modernization also supports Force Design through identifying optimal configurations of talent and by building capable units for sustained operations in the FOE.

Key Tasks:

Task 13.4.a: Define S&T Requirements and Gaps for Army People Strategy 2030

OPR: ASA(M&RA); **OCR:** ASA(ALT); DCS G-1; TRADOC

Current S&T investments by ARI and MRDC (WRAIR) address several the S&T requirements implied or explicated in the Army People Strategy (2020) and Military Implementation Plan (2020). The integration of additional lines of effort in APS 2030 highlights additional likely S&T requirements. Documenting the scope of S&T requirements from APS 2030 and identifying where requirements are or are not resourced is a critical first step in providing for the S&T necessary for modernizing the Army’s workforce.

Task End State: S&T requirements for APS 2030 are identified and enumerated as resourced, partially resourced, or unresourced given current approved programming

Army People Strategy: Military Implementation Plan 2.0

through POM23. S&T requirements for APS 2030 being addressed by MRDC are identified and enumerated as continued resourcing by Army, continued resourcing by DHA, or unresourced and the fiscal year that resourcing lapses.

Dependencies: None Identified.

Milestones:

Milestone 1: TBD through discussion with ASA(ALT)

Start Date: TBD; **End Date:** TBD

Balance Force Structure

Maintaining the All-Volunteer Army within the constraints of funding and end strength, while still meeting the Army's varied missions and readiness objectives is a continual challenge. After several years under difficult recruiting conditions, funding considerations, and changes in both the American public and the force itself, this only grows in complexity and importance. Core APS Lines of Effort, particularly Acquire, Employ, and Retain, have implications in the force structure. We must recruit enough talent with the right talents to fill entry-level positions, understanding that requirements for more experienced officers and enlisted Soldiers may drive over- or under-production of particular junior ranks or MOSs. We must fill critical MOSs. We must also ensure the personnel we employ are best aligned for the needs of the Army as well as respecting individual Soldier preferences whenever possible. Providing flexible and modern options to align talent is therefore critical to maintaining a healthy force structure. And finally, as we retain and transition talent, we must weigh what it takes to retain talents against the gaps we have to fill and make informed decisions about retention. Developing flexibilities like component permeability, in combination with more traditional levers of retention such as incentives help ensure the Army has the appropriate level of experienced, professional talent in more advanced ranks.



Chapter 14: Assessment
Military Implementation Plan 2.0

Army People Strategy: Military Implementation Plan 2.0

Assessment

Execution of the MIP is only as good as the ability to show progress. The APS strategic outcomes of Ready, Professional, Diverse, and Integrated are actioned primarily through the APS LOEs, which are implemented through the tasks, which in turn are tracked through milestones.

The strategic outcomes do not tie one-to-one with the LOEs, but some general relationships are apparent. Generally, talent acquisition and retention play directly into readiness; talent development is critical in professionalism; and employing people based on their KSB-Ps promotes inclusion and diversity. Integration of the components with each other and with DA Civilian activities is also generally considered as part of retention.

Measurement of MIP execution can therefore be considered at each of four tiers: milestone, task, objective/LOE, and overall.

Milestone Assessment

Milestones constitute the most granular level of information collected for the MIP. Each milestone has a notional start and end date. Prior to the start date, the milestone is not considered in tracking execution. Once within the execution period, the milestone status is reportable and counts toward the total number of milestones. A milestone within its execution window can be considered not yet begun, in-progress, or completed. Milestones should be completed by their given end dates. Any milestone not completed by the end date is considered overdue. Tasks with overdue milestones will be elevated for review and guidance in the governance meetings.

Data regarding milestone status will be provided by the OPR/OCR/Data Owner identified for each task and provided to the office of the DASA-MP for aggregation and maintenance of records.

Task Assessment

Tasks have two main assessment modalities. Measures have been attached to most tasks so we can measure each task's impact on those things they expect to directly impact. For example, **Task 3.1.j: Expand Marketing for the Army National Guard** will be able to directly measure how many leads were generated for the ARNG, trends in Cost per Lead, etc.—items they expect execution of the Task to directly impact. For a second example, **Task 5.2.a: Talent Based Branching (TBB)** will assess the relationship between TBB measures of fit and continuation in the Army—something the program should be directly impacting.

In the second assessment modality, task assessment can default to assessing based on milestone accomplishment. Milestone statuses assessed as completed on time will get full credit. Milestones in progress during the execution period will get half credit. Milestones not yet begun during the execution period receive no credit. Milestones completed late will receive credit only after concurrence of leadership through the

Army People Strategy: Military Implementation Plan 2.0

governance process and will receive only three-quarters credit. Milestones not yet complete and overdue receive no credit and will be elevated to the governance team for guidance. A notional example with 10 milestones is included below in Figure 13.

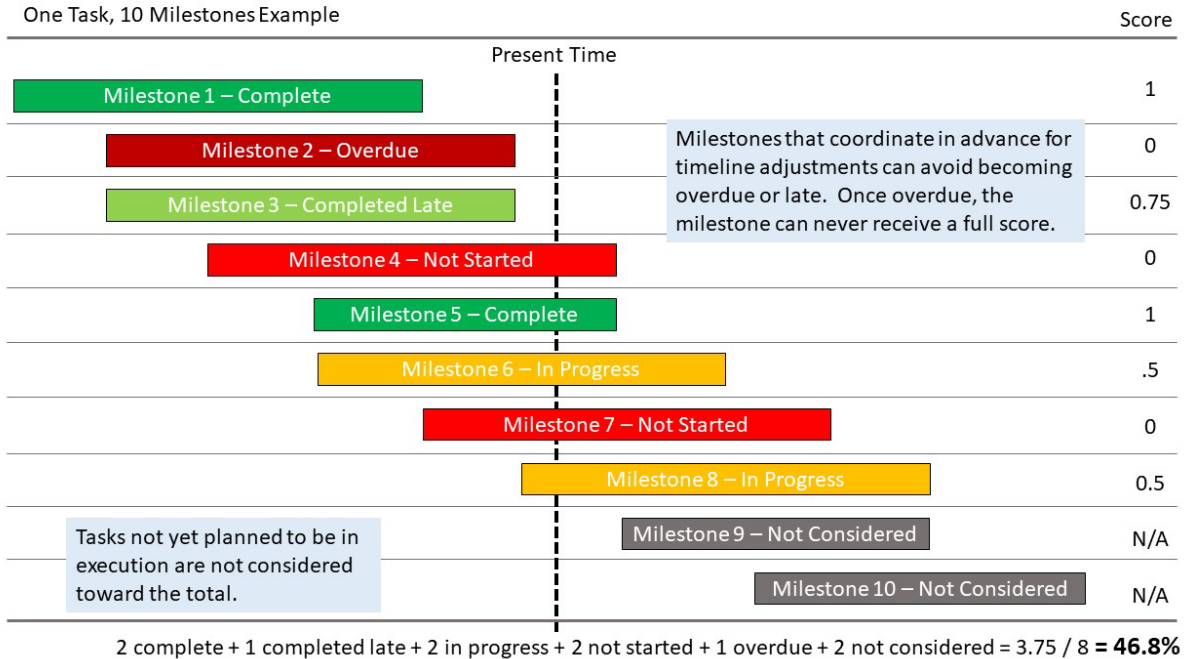

Figure 13: Milestone Scoring Example

Or, represented mathematically:

$$\begin{aligned}
 & [2 \text{ tasks complete } (1) + 1 \text{ task completed late } (0.75) + 2 \text{ tasks in progress } (0.5) \\
 & \quad + 2 \text{ tasks not started } (0) + 1 \text{ task overdue } (0) \\
 & \quad + 2 \text{ tasks not considered } (0)] / \\
 & [2 \text{ tasks not considered } (0) + 8 \text{ tasks considered } (1)] \\
 & = 3.75/8 = 46.8\%
 \end{aligned}$$

The first modality is preferred. Reasons to employ the second include if there is no measure developed, the measure assigned is insufficient, or the data for the measures is inadequate or inaccessible.

Objective/LOE Assessment

Measures have been developed for each of the 12 core APS Objectives, 44 in total. Overall objective performance will be assessed primarily using these measures. As a back-up and to provide more information, aggregated milestone status will be provided for all tasks within that objective. LOE assessment involves assessing the measures for each LOE's supporting objectives. Many measures have a goal articulated as "increase" or "decrease." While having goal values, e.g. "5%" or "200 participants," is better, many measures do not have an articulated goal value or even a measure of what amount of change is reasonable. Therefore, the value at the start of the reporting period will be

Army People Strategy: Military Implementation Plan 2.0

assumed to be normal, and the next six months of data will be used to baseline the amount of variation.

Overall Assessment

Fundamentally, the MIP must show progress in achieving the overall endstates of the APS. These are articulated through the APS strategic outcomes. A subset of the objective measures that are most broadly useful to evaluate the status of execution has been identified, and each has been aligned with a strategic outcome. This subset includes at least one measure from each APS objective. Each of the SECARMY People Enterprise objectives are mapped to related strategic outcomes. All such alignments are listed below.

READY -The Army uses a range of technologies, incentives, programs, and policies to identify the talents of its people and the talent demands of its organizations in timely, accurate, and granular detail. It applies data-driven analytical tools to its talent employment and development efforts. This data drives a dynamic and accurate long-term workforce planning system which reduces talent gaps and increases overall Army readiness. It also enables the Army to rapidly build appropriately talented special mission teams - ***cohesive teams that are trained, disciplined, and fit to win.***

Measure	Data Source/Provider	Goal if applicable
Percentage of youth propensed to serve in the Army	Source: JAMRS Youth Poll, as provided by AEMO	goal: increase
Conversion Rate from Marketing Qualified Leads to Contracts	Source: AEMO	goal: increase
Percentage of Recruiting mission accomplished	Source: DCS G-1 DMPM	goal: 100%
Percentage of recruits that finish initial training out of those who begin	Source: TRADOC CAC	goal: increase
Percentage of ROTC scholarship recipients who continue past sophomore year to contract as cadets	Source: USACC	goal: increase
Percentage out of all respondents of Soldiers indicating that “The mentorship I receive from my unit or organization leadership” is a reason to stay	Source: ATMTF	goal: increase “Reason to STAY” responses on DACES
Percentage of Soldiers in any movement cycle who retire in lieu of reassignment	Source: HRC	goal: decrease
Percent of fill of critical positions and MOSs	Source: DCS G-1 DMPM	goal: increase

Army People Strategy: Military Implementation Plan 2.0

SECARMY Objective 6 – Adapt Recruiting and Retention
--

PROFESSIONAL - *The Army is a profession, a highly expert, certified, and credentialed force resulting from years of increasingly rigorous training, education, and leader development. Its people treat one another with dignity and respect, retaining the trust and confidence of both the American people and each other. Army professionals are people of character, presence, and intellect, committed to reflective practice and continuous learning. They share a powerful and enduring identity as lifelong members of the Army team.*

Measure	Data Source/Provider	Goal if applicable
Percentage of the total force that participated in a diagnostic assessment via Project Athena out of the number eligible	Source: TRADOC CAC	
Rate at which Soldiers seeking credentials pass credentialing examinations	Source: TRADOC/Army University/CAC	goal: increase
SECARMY Objective 4 – Build Positive Command Climates		
SECARMY Objective 5 – Prevent/Reduce Harmful Behaviors		

DIVERSE - *The Army is committed to equality of opportunity, providing all talented people with fulfilling and rewarding professional careers. As an inclusive and representative American institution, we ensure that our people possess a diversity of talent – knowledge, skills, behaviors, and preferences – drawn from all corners of our country and its vibrant, diverse population.*

Measure	Data Source/Provider	Goal if applicable
Percent of Soldiers in the Talent Marketplace listing KSB-Ps in their profiles	Source: HRC	goal: increase
Percent of units in the Talent Marketplace using KSB-Ps in their job announcements	Source: HRC	goal: increase
Percentage out of all respondents of Soldiers indicating “Opportunities to use my skills and abilities” is a reason to stay	Source: ATMTF	goal: increase “Reason to STAY” responses on DACES
Percentage of brevetable positions filled by breveted Soldiers	Source: HRC	

Army People Strategy: Military Implementation Plan 2.0

Percentage of captains who accept a Talent Based Career Alignment out of those who are offered TBCA	Source: HRC ORD	
SECARMY Objective 4 – Build Positive Command Climates		

INTEGRATED - *The Army has overcome legal, cultural, and technological barriers to fully harmonize the efforts and capabilities of its Total Force: Active, Guard, Reserve Soldiers, and Civilians. This transformation has dramatically increased workforce permeability between the Active, Guard, and Reserve, between Soldiers and Civilians, to the benefit of both the Army and its people.*

Measure	Data Source/Provider	Goal if applicable
Count of Soldiers crossing components	Source: HRC	goal: increase

Note that Ready is clearly the largest strategic outcome by count of associated measures, which reflects the Army’s continued emphasis on recruiting adequately, retaining top talent, and meeting end strength. Integrated is the smallest because permeability as currently understood is relatively new and developing. SECARMY Objective 2 – *Data-centric Army* is cross-cutting, and in fact enables the enhanced measurements built into MIP 2.0.

Data Visualization

For the convenience of senior leadership, the selected set of high-level objective measures will be displayed on a dashboard regularly to show both current status and progress. As execution proceeds and data processes and metrics are matured, increasing degrees of data drilldown will be incorporated to support trend analysis, anomaly detection, and decision-making. Envisioned is an APS Dashboard that enables drilldown on the APS strategic outcomes, the APS lines of effort, or the SECARMY’s objectives, as needed, down to the level of APS milestone accomplishment.

APS objective-level measures are currently expected to be monitored in a dashboard developed through the Army People Analytics Office. Milestone status will be collected through a dedicated Microsoft Teams channel.



Acronym List
Military Implementation Plan 2.0

Army People Strategy: Military Implementation Plan 2.0

Acronym List

AAA	Army Audit Agency
AAFES	Army and Air Force Exchange Service
ACCESS	Army Credentialing and Continuing Education Systems for Soldiers
ACFT	Army Combat Fitness Test
ACM	Army Capabilities Managers
ACP	Army Coaching Program
ADEIC	Army Diversity, Equity, and Inclusion Council
ADL	Active-Duty List
ADS	Authoritative Data Source
ADTS	Army Digital Transformation Strategy
AEAP	Army Enterprise Assessment Program
AEAS	Army Enterprise Assessment System
AEMO	Army Enterprise Marketing Office
AFC	Army Futures Command
AFQT	Armed Forces Qualification Test
AHRPO	Army Human Research Protections Office
AI	Artificial Intelligence
AIE	Accessions Information Environment
AIM	Assignment Interactive Module
AIPS	Army Integrated Prevention Strategy
AIT	Advanced Individual Training
ALC	Army Learning Concept
ALCC	Army Learning Coordination Council
AMC	Army Materiel Command
APAO	Army People Analytics Office
APS	Army People Strategy
APS-BoD	Army People Strategy Board of Directors
APT	Army Personnel Testing
ARD	Army Resiliency Directorate
ARI	Army Research Institute
ARMS	Assessment of Recruit Motivation and Strength
ARNG	Army National Guard
ARSTAF	Army Staff
ARSTRUC	Army Structure
ARTF	Army Recruiting and Retention Task Force
ARTT	Accessions/Recruiting Tiger Team
ASA(ALT)	Assistant Secretary of the Army for Acquisition, Logistics, and Technology
ASA(M&RA)	Assistant Secretary of the Army for Manpower and Reserve Affairs
ASAP	Army Substance Abuse Program
ASCC	Army Commands, Army Service Component Command

Army People Strategy: Military Implementation Plan 2.0

ASL	Army Senior Leadership
ASOHMS	Army Safety Occupational Health Management System
ATAF	Army Talent Attribute Framework
ATIS	Army Training Information System
ATMTF	Army Talent Management Task Force
BCT	Basic Combat Training
BOLC	Basic Officer Leaders Course
CA	Credentialing Assistance
CAC	Combined Arms Center
CAP	Command Assessment Program
CAPL	Center for the Army Profession and Leadership
CASAL	Conduct an Annual Survey of Leader Perceptions
CAT	Cohesion Assessment Team
CGSC	Command and General Staff College
CIMT	Center for Initial Military Training
C-InT	Counter-Insider Threat
CIO	Chief Information Officer
CIP	Civilian Implementation Plan
CMP	Change Management Plan
CMSP-T	Career Mapping and Succession Planning Tool
COA	Course of Action
COAD	Continuation on Active Duty
COAR	Continuation on Active Reserve Status
COE	Centers of Excellence
CORBT	Council on Recruit Basic Training
COTS	Commercial Off The Shelf
COVID	Coronavirus Disease
CSA	Chief of Staff of the Army
CSEP	Common Scenario Exercise Program
CSF2	Comprehensive Soldier and Family Fitness
CSL	Centralized Selection List
CTC	Combat Training Center
DA	Department of the Army
DA PAM	Department of the Army Pamphlet
DACES	Department of the Army Career Engagement Survey
DASA-MP	Deputy Assistant Secretary of the Army - Manpower
DCS	Deputy Chief of Staff
DEIA	Diversity, Equity, Inclusion, and Accessibility
DES	Disability Evaluation System
DHA	Defense Health Agency
DLL	Digital Learning Lab
DMO	Directed Military Overstrength

Army People Strategy: Military Implementation Plan 2.0

DMPM	Directorate of Military Personnel Management
DOD	Department of Defense
DoDI	Department of Defense Instruction
DOL	Department of Labor
DRU	Direct Reporting Unit
ECP	Enterprise Classroom Program
ECW	Extreme Cold Weather
EEO	Equal Employment Opportunity
EFM	Exceptional Family Member
EFMP	Exceptional Family Member Program
EMM	Enterprise Marketing Management
ESC	Executive Steering Committee
ESOH	Environment, Safety and Occupational Health
ETL	Emerging Technology Leader
EXORD	Execution Order
FA	Functional Area
FCC	Family Child Care
FHIRC	Fort Hood Independent Review Committee
FM	Field Manual
FOC	Full Operational Capability
FRAGO	Fragmentary Order
FY	Fiscal Year
GAO	Government Accountability Office
GD	Gender Discrimination
GPS	Global Positioning System
H2F	Holistic Health and Fitness
HQDA	Headquarters Department of the Army
HRC	Human Resources Command
IAW	In Accordance With
ICF	International Coaching Federation
IDA	Institute for Defense Analyses
IDP	Individual Development Plan
IET	Initial Entry Training
IMCOM	Installation Management Command
IMT	Initial Military Training
IPPS-A	Integrated Personnel and Pay System - Army
IRB	Institutional Review Board
IRC	Independent Review Commission
IRR	Individual Ready Reserve
IRT	Item Response Theory
ISO	In Support Of
JAMRS	Joint Advertising Market Research and Studies

Army People Strategy: Military Implementation Plan 2.0

JCIDS	Joint Capabilities Integration and Development System
JML	Journal for Military Learning
JROTC	Junior Reserve Officer Training Corps
JST	Joint Service Transcript
KSB	Knowledge, Skills, and Behaviors
KSB-P	Knowledge, Skills, Behaviors, and Preferences
LOE	Line of Effort
MAR2	MOS/Administrative Retention Review
MDEP	Management Decision Package
MDO	Multi-Domain Operations
MEC	Mission Essential Condition
MEO	Military Equal Opportunity
MEPS	Military Entrance Processing Station
MET	Mission Essential Task
MIP	Military Implementation Plan
ML	Machine Learning
MOS	Military Occupational Specialty
MOU	Memorandum of Understanding
MRD	Medical Research Development
MRDC	Medical Research and Development Command
MTF	Medical Treatment Facility
MWR	Morale, Welfare, and Recreation
MyCAA	My Career Advancement Account
NCO	Non-Commissioned Officer
NCOLCoE	Non-Commissioned Officer Leadership Center of Excellence
NDAA	National Defense Authorization Act
NGR	National Guard Regulation
NLT	No Later Than
OE	Operational Environment
OEMA	Office of Economic and Manpower Analysis
OML	Order of Merit List
OPR	Office of Primary Responsibility
OTJAG	Office of the Judge Advocate General
OTSG	Office of the Surgeon General
OUSD(P&R)	Office of the Under Secretary of Defense (Personnel and Readiness)
PA-CFG	People Analytics Cross-Functional Group
PCS	Permanent Change of Station
PD/Exe. Ed.	Professional Development and Executive Education
PDE	Personnel Data Environment
PEGs	Program Evaluation Groups
PEO-EIS	Program Executive Office for Enterprise Information Systems
PFL	Prime For Life

Army People Strategy: Military Implementation Plan 2.0

PFTF	People First Task Force
PME	Professional Military Education
POAM	Plan of Action and Milestones
POC	Point of Contact
POI	Program of Instruction
POM	Program Objective Memorandum
PPBE	Planning, Programming, Budgeting, and Execution
PWF	Prevention Workforce
QOL	Quality of Life
QPTB	Quarterly People and Training Brief
QTB	Quarterly Training Brief
R&D	Research and Development
R2	Risk and Resiliency
RASL	Reserve Active Status List
RDTE	Research, Development, Test and Evaluation
ReARMM	Regionally Aligned Readiness and Modernization Model
REDCAT	Race and Ethnic Designation Category
RMF	Risk Management Framework
RMO	Regional Marketing Office
ROTC	Reserve Officers' Training Corps
RPM-A	Retention Prediction Model-Army
RRNCO	Recruiting and Retention Non-Commissioned Officer
RSP	Recruit Sustainment Program
S&T	Science and Technology
SA	Sexual Assault
SAPR VA	Sexual Assault Prevention and Response Victim Advocate
SARC	Sexual Assault Response Coordinator
SDS	School District Strategy
SECARMY	Secretary of the Army
SECO	Spouse Education & Career Opportunities
SELRES	Selected Reserve
SFL	Soldier for Life
SH	Sexual Harassment
SHARP	Sexual Harassment/Assault Response and Prevention
SLSC	Senior Leader Steering Committee
SMAP	Sergeant Major Assessment Program
SO&EH	Safety, Occupational, and Environmental Health
SP	Suicide Prevention
SPRC	Soldier Performance Readiness Centers
SPRIRC	Suicide Prevention and Response Independent Review Committee
SSE	Strategic Stakeholder Engagement
STE	Synthetic Training Environment

Army People Strategy: Military Implementation Plan 2.0

STE-IS	Synthetic Training Environment-Information System
STEM	Science, Technology, Engineering and Mathematics
STRATCOM	Strategic Communication
T&EO	Training and Evaluation Outline
TA	Tuition Assistance
TAA	Total Army Analysis
TADLP	The Army Distributed Learning Program
TAPAS	Tailored Adaptive Personality Assessment System
TAS	Talent Assessments Strategy
TBB	Talent Based Branching
TBCA	Talent Based Career Alignment
TBD	To Be Determined
TDA	Table of Distributions and Allowances
TOMS	TRADOC Organic Medical Structure
TOPMIS	Total Officer Personnel Management Information System
TRADOC	Training and Doctrine Command
TRADOC CAC	Training and Doctrine Command Combined Arms Center
TRADOC CAC-T	Training and Doctrine Command Combined Arms Center - Training
UFR	Unfinanced Requirement
USACC	United States Army Cadet Command
USACE	United States Army Corps of Engineers
USAMAA	United States Army Manpower Analysis Agency
USAR	United States Army Reserve
USAREC	United States Army Recruiting Command
USD(P&R)	Undersecretary of Defense for Personnel and Readiness
USMA	United States Military Academy
USR	Unit Status Report
VCSA	Vice Chief of Staff of the Army
VOLED	Voluntary Education
WFX	Warfighter Exercise
WG	Working Group

